

Dell Embedded Box PC 5000 Service Manual

Computer Model: Dell Embedded Box PC 5000
Regulatory Model: N01PC
Regulatory Type: N01PC001



Notes, cautions, and warnings



NOTE: A NOTE indicates important information that helps you make better use of your product.



CAUTION: A CAUTION indicates either potential damage to hardware or loss of data and tells you how to avoid the problem.



WARNING: A WARNING indicates a potential for property damage, personal injury, or death.

Copyright © 2017 Dell Inc. or its subsidiaries. All rights reserved. Dell, EMC, and other trademarks are trademarks of Dell Inc. or its subsidiaries. Other trademarks may be trademarks of their respective owners.

2017 - 03

Rev. A01

Contents

- Before working inside your Embedded Box PC..... 11**
 - Before you begin.....11
 - Safety instructions.....11
 - Recommended tools..... 12
 - Screw list..... 13

- After working inside your Embedded Box PC.....15**

- Technical overview..... 16**
 - System-board components..... 17

- Removing the back cover..... 19**
 - Procedure..... 20

- Replacing the back cover..... 23**
 - Procedure.....23

- Removing the hard-drive cage..... 24**
 - Prerequisites.....24
 - Procedure.....24

- Replacing the hard-drive cage..... 26**
 - Procedure..... 26
 - Post-requisites 26

- Removing the drives from the hard-drive cage.....27**
 - Prerequisites.....27
 - Procedure.....27



Procedure to remove bottom drive.....	28
Replacing the drives in to the hard-drive cage.....	30
Procedure.....	30
Procedure to replace bottom drive.....	30
Post-requisites	30
Removing the solid-state drive from bracket.....	31
Prerequisites.....	31
Procedure.....	31
Replacing the solid-state drive in to bracket.....	33
Procedure.....	33
Post-requisites	33
Removing the interposer board.....	34
Prerequisites.....	34
Procedure.....	34
Replacing the interposer board.....	36
Procedure.....	36
Post-requisites	36
Installing a PCI/PCIe card.....	37
Prerequisites.....	37
Procedure.....	38
Post-requisites	42
Removing the PCI/PCIe card.....	43
Prerequisites.....	43
Procedure.....	44



Replacing the PCIe card.....	47
Procedure.....	47
Post-requisites	49
Removing the memory module.....	50
Prerequisites.....	50
Procedure.....	50
Replacing the memory module.....	52
Procedure.....	52
Post-requisites	54
Removing the WLAN-antenna connectors.....	55
Prerequisites.....	55
Procedure.....	55
Replacing the WLAN-antenna connectors.....	58
Procedure.....	58
Post-requisites	58
Removing the WLAN card.....	59
Prerequisites.....	59
Procedure.....	59
Replacing the WLAN card.....	61
Procedure.....	61
Post-requisites	63
Removing the WWAN-antenna connectors.....	64
Prerequisites.....	64
Procedure.....	64



Replacing the WWAN-antenna connectors.....	67
Procedure.....	67
Post-requisites	67
Removing the WWAN card.....	68
Prerequisites.....	68
Procedure.....	68
Replacing the WWAN card.....	70
Procedure.....	70
Post-requisites	72
Removing the SIM card.....	73
Prerequisites.....	73
Procedure.....	73
Replacing the SIM card.....	75
Procedure.....	75
Post-requisites	76
Removing the CANbus cable.....	77
Prerequisites.....	77
Procedure.....	77
Replacing the CANbus cable.....	79
Procedure.....	79
Post-requisites	79
Removing the CANbus card.....	80
Prerequisites.....	80
Procedure.....	80



Replacing the CANbus card.....	82
Procedure.....	82
Post-requisites	83
Removing the coin-cell battery.....	84
Prerequisites.....	84
Procedure.....	84
Replacing the coin-cell battery.....	86
Procedure.....	86
Post-requisites	86
Removing the intrusion switch.....	87
Prerequisites.....	87
Procedure.....	87
Replacing the intrusion switch.....	89
Procedure.....	89
Post-requisites	89
Removing the serial ports.....	90
Prerequisites.....	90
Procedure.....	91
Replacing the serial ports.....	93
Procedure.....	93
Post-requisites	93
Removing the bottom cover.....	94
Prerequisites.....	94
Procedure.....	94



Replacing the bottom cover.....	96
Procedure.....	96
Post-requisites	96
Removing the riser card.....	97
Prerequisites.....	97
Procedure.....	97
Replacing the riser card.....	100
Procedure.....	100
Post-requisites	100
Removing the heat sink.....	101
Prerequisites.....	101
Procedure.....	101
Replacing the heat sink.....	103
Procedure.....	103
Post-requisites	104
Removing the power connectors.....	105
Prerequisites.....	105
Procedure.....	105
Replacing the power connectors.....	108
Procedure.....	108
Post-requisites	108
Removing the top cover.....	109
Prerequisites.....	109
Procedure.....	109



Replacing the top cover.....	112
Procedure.....	112
Post-requisites	112
Removing the power switch.....	113
Prerequisites.....	113
Procedure.....	113
Replacing the power switch.....	115
Procedure.....	115
Post-requisites	115
Removing the CPU board.....	116
Prerequisites.....	116
Procedure.....	116
Replacing the CPU board.....	118
Procedure.....	118
Post-requisites	118
Removing the system board.....	119
Prerequisites.....	119
Procedure.....	120
Replacing the system board.....	123
Procedure.....	123
Post-requisites.....	123
Entering the Service Tag in the BIOS setup program.....	124



- BIOS setup program..... 125**
 - Entering BIOS setup program..... 125
 - Clearing forgotten passwords..... 125
 - Clearing CMOS settings..... 126

- Removing the Dell logo board..... 128**
 - Prerequisites..... 128
 - Procedure..... 129

- Replacing the Dell logo board..... 132**
 - Procedure..... 132
 - Post-requisites..... 132

- Technology and components..... 134**
 - Power..... 134
 - Processor..... 134
 - Mechanical..... 134
 - Peripherals..... 135
 - WLAN/WWAN..... 135
 - Zigbee..... 135
 - CANbus..... 136



Before working inside your Embedded Box PC



NOTE: The images in this document may differ from your Embedded Box PC depending on the configuration you ordered.

Before you begin

- 1 Save and close all open files and exit all open applications.
- 2 Shut down the Embedded Box PC.

The shut-down instruction varies depending on the operating system installed on the Embedded Box PC.



NOTE: For more information, see the documentation of your operating system for shut-down instructions.

- 3 Disconnect the Embedded Box PC and all attached devices from their electrical outlets.
- 4 Disconnect all cables such as network cables from the Embedded Box PC.
- 5 Disconnect all attached devices and peripherals, such as keyboard, mouse, and monitor, from the Embedded Box PC.
- 6 After the Embedded Box PC is unplugged, press and hold the power button for 5 seconds to ground the system board.







Safety instructions

Use the following safety guidelines to protect your Embedded Box PC from potential damage and ensure your personal safety.



WARNING: Before working inside your Embedded Box PC, read the safety information that shipped with your Embedded Box PC and follow the steps in [Before working inside your Embedded Box PC](#). After working inside your Embedded Box PC, follow the steps in [After working inside your Embedded Box PC](#). For more safety best practices, see the Regulatory Compliance home page at www.dell.com/regulatory_compliance.



-  **WARNING:** Disconnect all power sources before opening the Embedded Box PC cover or panels. After you finish working inside the Embedded Box PC, replace all covers, panels, and screws before connecting to the electrical outlet.
-  **CAUTION:** To avoid damaging the Embedded Box PC, ensure that the work surface is flat and clean.
-  **CAUTION:** To avoid damaging the components and cards, handle them by their edges, and avoid touching pins and contacts.
-  **CAUTION:** You should only perform troubleshooting and repairs as authorized or directed by the Dell technical assistance team. Damage due to servicing that is not authorized by Dell is not covered by your warranty. See the safety instructions that shipped with the product or at www.dell.com/regulatory_compliance.
-  **CAUTION:** Before touching anything inside your Embedded Box PC, ground yourself by touching an unpainted metal surface, such as the metal at the back of the Embedded Box PC. While you work, periodically touch an unpainted metal surface to dissipate static electricity, which could harm internal components.
-  **CAUTION:** When you disconnect a cable, pull on its connector or on its pull tab, not on the cable itself. Some cables have connectors with locking tabs or thumb-screws that you must disengage before disconnecting the cable. When disconnecting cables, keep them evenly aligned to avoid bending any connector pins. When connecting cables, ensure that the ports and connectors are correctly oriented and aligned.
-  **CAUTION:** Press and eject any installed card from the media-card reader.

Recommended tools

The procedures in this document may require the following tools:

- Philips screwdriver
- Flat-head screwdriver
- Plastic scribe
- Hex screwdriver

- 8 mm open wrench
- 10 mm open wrench

Screw list

The following table provides the list of screws used for securing different components to the Embedded Box PC.

Component	Secured to	Screw type	Quantity
Logo board	Front chassis	M3x5	3
Left chassis	Front chassis	M3x6	7
Right chassis	Front chassis	M3x6	7
System board	Front chassis	M3x5	9
	Front chassis	STDF(L8) HEX, M3x4	5
	Front chassis	STDF(L15) HEX, M3x4	1
CPU board	System board	STDF(L5) HEX, M2.5x4	3
	System board	M2.5x6	2
Heat sink	CPU board	M3x8	4
	Left chassis	M3x16	4
	Right chassis	M3x16	4
Riser card	Riser card bracket	M3x5	2
Riser card	Right chassis	M3x5 countersunk	2
WLAN card	Carrier board	M2x3	2
WWAN card	Carrier board	M2x3	2
PCI cover	Top PCI plate	M3x5 countersunk	1
PCI cover	Top PCI plate	M3x5 countersunk	1
PCI bracket	Top PCI plate	M3x5 countersunk	1
DC-in connector	Top PCI plate	M2.5x6	2
Intrusion switch	Intrusion-switch bracket	M2x10	1



Component	Secured to	Screw type	Quantity
	Top PCI plate	M3x5 countersunk	1
VGA connector	Top PCI plate	D-sub HEX, #4-40UNCx6.3	2
CANbus cable	Top PCI plate	D-sub HEX, #4-40UNCx6.3	2
Top I/O plate	Main chassis	M3x5 countersunk	7
COM port cable	Bottom I/O plate	D-sub HEX, #4-40UNCx6.3	8
Bottom I/O plate	Main chassis	M3x5 countersunk	7
Rubber foot	Back cover	M3x8	4
Back cover	Main chassis	M3x5 countersunk	5
Hard-drive cage	Back cover	M3x5	4
Top hard drive/solid-state drive	Hard-drive cage	STDF(L5.1), M3x3	4
Bottom hard drive/solid-state drive	Hard-drive cage	STDF(L5.1), M3x3	4
Solid-state drive interposer board	Solid-state drive carrier	M2x3	3
Solid-state drive	Solid-state drive carrier	M2x3	2
Wall-mount bracket	Back cover	M3x8	4

After working inside your Embedded Box PC



CAUTION: Leaving stray or loose screws inside your Embedded Box PC may severely damage your Embedded Box PC.

- 1** Replace all screws and ensure that no stray screws remain inside the Embedded Box PC.
- 2** Connect any external devices, peripherals, or cables you removed before working on the Embedded Box PC.
- 3** Connect your Embedded Box PC and all attached devices to their electrical outlets.
- 4** Turn on the Embedded Box PC.



Technical overview



WARNING: Before working inside your Embedded Box PC, read the safety information that shipped with your Embedded Box PC and follow the steps in [Before working inside your Embedded Box PC](#). After working inside your Embedded Box PC, follow the steps in [After working inside your Embedded Box PC](#). For more safety best practices, see the Regulatory Compliance home page at www.dell.com/regulatory_compliance.

System-board components

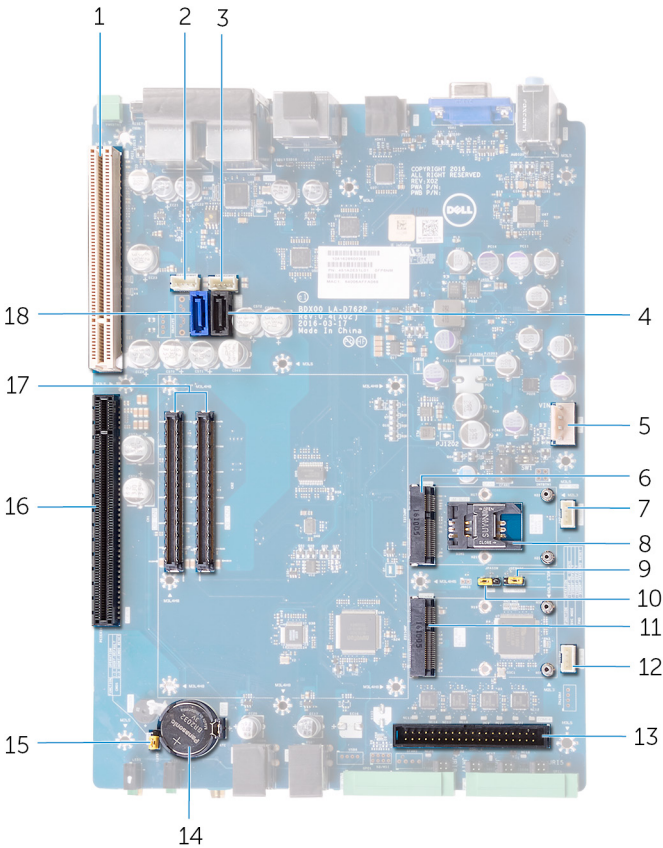

- | | | | |
|---|--|---|-------------------------------------|
| 1 | PCI slot | 2 | SATA power-connector one (SATAPWR1) |
| 3 | SATA power-connector two (SATAPWR2) | 4 | SATA data-connector one (SATA2) |
| 5 | power cable connector (PWR IN) | 6 | mPCIe connector one (CAN BUS/WWAN) |
| 7 | intrusion-switch cable connector (INTRUSION) | 8 | SIM-card slot (SIM SLOT) |



9	service mode reset jumper (SVC MODE)	10	password reset jumper (PWD)
11	mPCIe connector two (CAN BUS/WLAN/BT)	12	remote power-button cable connector (PWR BTN)
13	serial-port cable connector	14	coin-cell battery socket
15	CMOS reset jumper (CMOS)	16	PClex16 slot
17	CPU-board connector (DB CN1 & DB CN2)	18	SATA data-connector two (SATA1)



Removing the back cover



WARNING: Before working inside your Embedded Box PC, read the safety information that shipped with your Embedded Box PC and follow the steps in [Before working inside your Embedded Box PC](#). After working inside your Embedded Box PC, follow the steps in [After working inside your Embedded Box PC](#). For more safety best practices, see the Regulatory Compliance home page at www.dell.com/regulatory_compliance.



Procedure

- 1 Remove the screws that secure the back cover to the chassis.



- | | | | |
|---|-----------------|---|-----------------------------|
| 1 | M3x8 screws (4) | 2 | M3x5 countersunk screws (5) |
| 3 | rubber feet (4) | 4 | back cover |
| 5 | chassis | | |

- 2 Open the back cover from the chassis.
- 3 Disconnect the SATA-power and SATA-data cable from the hard drive or solid-state drive assembly.

 **NOTE: Disconnect the cables from the second drive if installed.**

- 4 Remove the cables from the routing guides on the top cover.

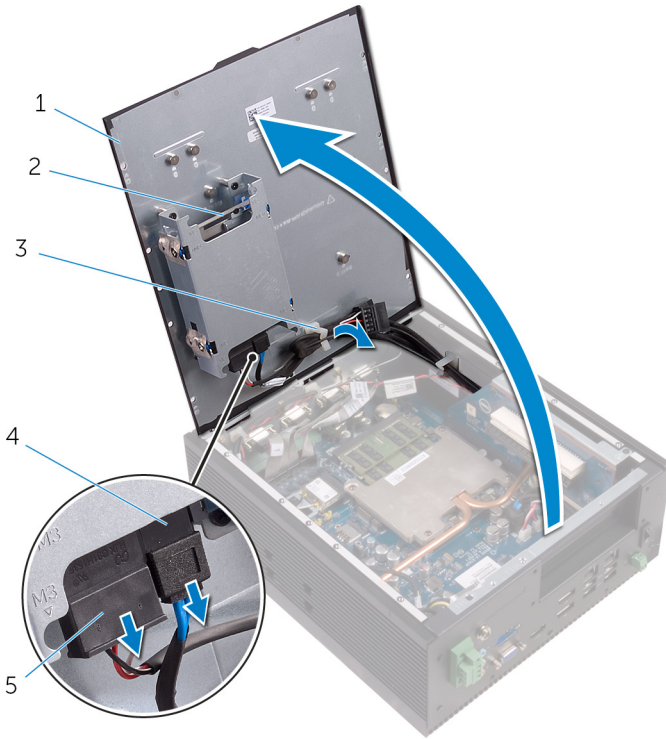

- | | | | |
|---|------------------|---|---------------------------------------|
| 1 | back cover | 2 | hard drive/Solid-state drive assembly |
| 3 | routing guide | 4 | SATA-data cable |
| 5 | SATA-power cable | | |

- 5 Close the back cover partially and push the back cover forward to release it from the tabs on the chassis.



- 6** Lift the back cover off the chassis.

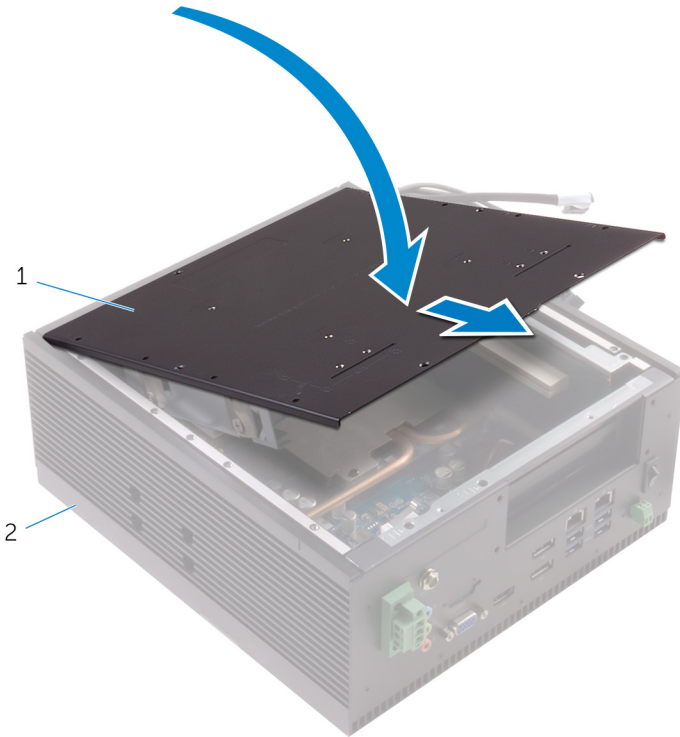

1 back cover

2 chassis

- 7** Remove the [Removing the hard-drive cage](#).

Replacing the back cover



WARNING: Before working inside your Embedded Box PC, read the safety information that shipped with your Embedded Box PC and follow the steps in [Before working inside your Embedded Box PC](#). After working inside your Embedded Box PC, follow the steps in [After working inside your Embedded Box PC](#). For more safety best practices, see the Regulatory Compliance home page at www.dell.com/regulatory_compliance.

Procedure

- 1 Replace the [hard-drive cage](#).
- 2 Insert the tabs on back cover at an angle into the slots on the chassis.
- 3 Open the back cover.
- 4 Route the SATA-power and SATA-data cables through the routing guides.
- 5 Connect the SATA-power and SATA-data cable to the hard drive or solid-state drive assembly.





NOTE: Connect the cables to the second drive if installed.

- 6 Close the back cover.
- 7 Align the screw holes on the back cover with the screw holes on the chassis.
- 8 Replace screws that secure the back cover to the chassis.



Removing the hard-drive cage

-  **WARNING:** Before working inside your Embedded Box PC, read the safety information that shipped with your Embedded Box PC and follow the steps in [Before working inside your Embedded Box PC](#). After working inside your Embedded Box PC, follow the steps in [After working inside your Embedded Box PC](#). For more safety best practices, see the Regulatory Compliance home page at www.dell.com/regulatory_compliance.
-  **CAUTION:** Hard drives/solid-state drives are fragile. Exercise care when handling the Solid-state/hard drive.
-  **CAUTION:** To avoid data loss, do not remove the hard drive/solid-state drive while the Embedded Box PC is in sleep or on state.

Prerequisites

Follow step 1 to step 6 in "[Removing the back cover](#)".

Procedure

- 1 Remove the screws that secure the hard-drive cage to the back cover.

2 Lift the hard-drive cage from the back cover.

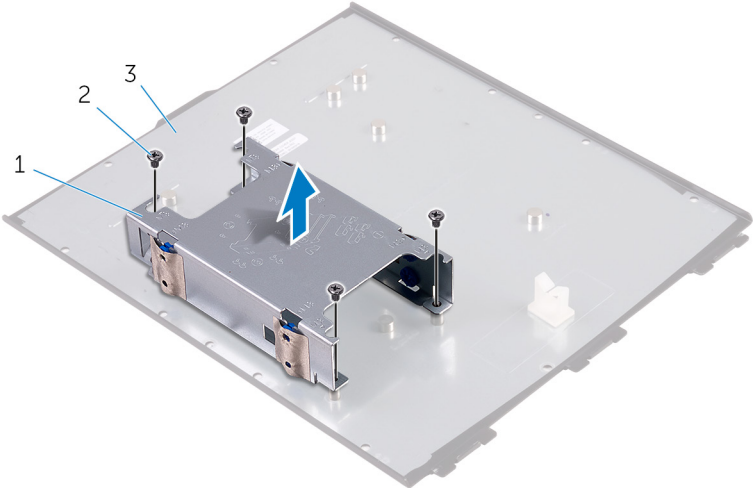

- 1 hard-drive cage
- 3 back cover

2 M3x5 screws(4)



Replacing the hard-drive cage

 **WARNING:** Before working inside your Embedded Box PC, read the safety information that shipped with your Embedded Box PC and follow the steps in [Before working inside your Embedded Box PC](#). After working inside your Embedded Box PC, follow the steps in [After working inside your Embedded Box PC](#). For more safety best practices, see the Regulatory Compliance home page at www.dell.com/regulatory_compliance.

 **CAUTION:** Hard drives/solid-state drives are fragile. Exercise care when handling the Solid-state/hard drive.



Procedure

- 1 Align the screw holes on the hard-drive cage with the screw holes on the back cover.
- 2 Replace the screws that secure the hard-drive cage to the back cover.

Post-requisites

Follow step 2 to step 8 in [“Replacing the back cover”](#).

Removing the drives from the hard-drive cage

-  **WARNING:** Before working inside your Embedded Box PC, read the safety information that shipped with your Embedded Box PC and follow the steps in [Before working inside your Embedded Box PC](#). After working inside your Embedded Box PC, follow the steps in [After working inside your Embedded Box PC](#). For more safety best practices, see the Regulatory Compliance home page at www.dell.com/regulatory_compliance.
-  **CAUTION:** Hard drives/solid-state drives are fragile. Exercise care when handling the Solid-state/hard drive.
-  **CAUTION:** To avoid data loss, do not remove the hard drive/solid-state drive while the Embedded Box PC is in sleep or on state.

Prerequisites

Follow step 1 to step 6 in "[Removing the back cover](#)".

Procedure

 **NOTE:** Embedded Box PC is shipped with hard drive, solid-state drive, or both, depending on the configuration ordered.

- 1 Remove the screws that secure the top drive to the hard-drive cage.



- 2 Slide the top drive out of the hard-drive cage.

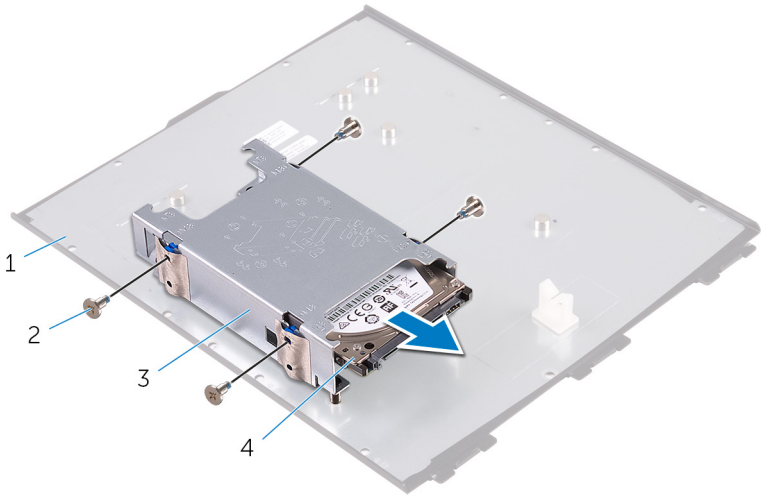

- | | | | |
|---|-----------------|---|------------------------------|
| 1 | back cover | 2 | STDF (L5.1), M3x3 screws (4) |
| 3 | hard-drive cage | 4 | hard drive/solid-state drive |

Procedure to remove bottom drive

- 1 Remove the screws that secure the bottom drive to the hard-drive cage.

2 Lift and slide the bottom drive out of the hard-drive cage.

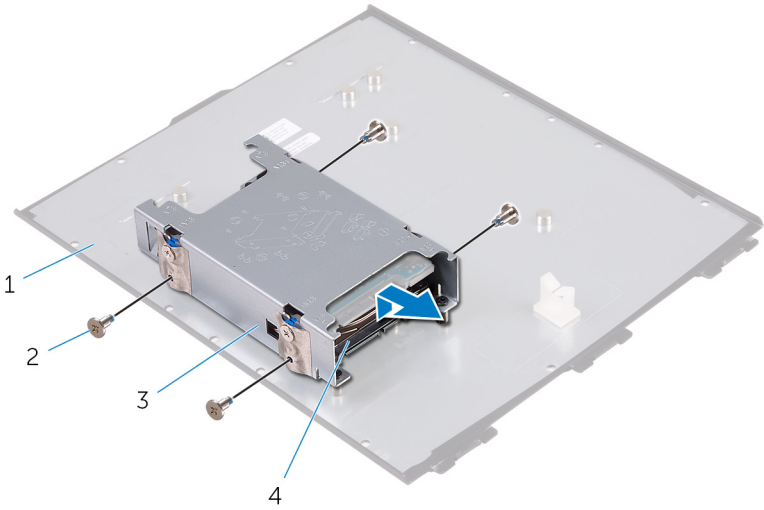

1 back cover

3 drive cage

2 STDF (L5.1), M3x3 screws(4)

4 hard drive/solid-state drive



Replacing the drives in to the hard-drive cage

 **WARNING:** Before working inside your Embedded Box PC, read the safety information that shipped with your Embedded Box PC and follow the steps in [Before working inside your Embedded Box PC](#). After working inside your Embedded Box PC, follow the steps in [After working inside your Embedded Box PC](#). For more safety best practices, see the Regulatory Compliance home page at www.dell.com/regulatory_compliance.

 **CAUTION:** Hard drives/solid-state drives are fragile. Exercise care when handling the Solid-state/hard drive.

Procedure

 **NOTE:** If the Embedded Box PC is shipped with two drives, the bottom drive has to be replaced first. For more information see, [Procedure to replace bottom drive](#).

- 1 Insert the drive into the hard-drive cage.
- 2 Align the screw holes on the drive with the screw holes on the hard-drive cage.
- 3 Replace the screws that secure the hard drive to the hard-drive cage.

Procedure to replace bottom drive

- 1 Insert the bottom drive into the bottom slot of the hard-drive cage and push it down into place.
- 2 Align the screw holes on the bottom drive with the screw holes on the hard-drive cage.
- 3 Replace the screws that secure the bottom drive to the hard-drive cage.

Post-requisites

Follow step 2 to step 8 in [“Replacing the back cover”](#).

Removing the solid-state drive from bracket



WARNING: Before working inside your Embedded Box PC, read the safety information that shipped with your Embedded Box PC and follow the steps in [Before working inside your Embedded Box PC](#). After working inside your Embedded Box PC, follow the steps in [After working inside your Embedded Box PC](#). For more safety best practices, see the Regulatory Compliance home page at www.dell.com/regulatory_compliance.



CAUTION: Solid-state drives are fragile. Exercise care when handling the solid-state drive.

Prerequisites

- 1 Follow step 1 to step 6 in "[Removing the back cover](#)".
- 2 Remove the [drives from the hard-drive cage](#).

Procedure



NOTE: Embedded Box PC is shipped with hard drive, solid-state drive, or both, depending on the configuration ordered.

- 1 Remove the screw that secures the solid-state drive to the solid-state drive bracket.



2 Remove the solid-state drive from the solid-state drive slot.

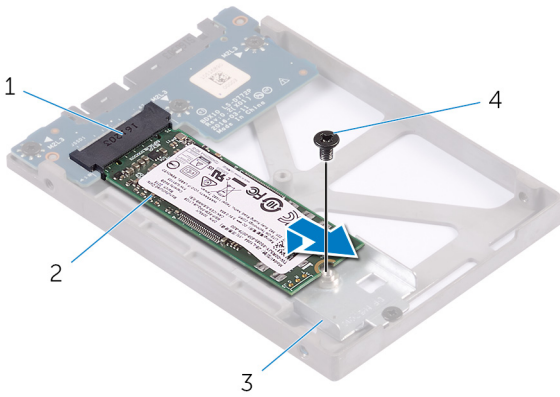

1 solid-state drive slot

2 solid-state drive

3 solid-state drive bracket

4 M2x3 screw

Replacing the solid-state drive in to bracket



WARNING: Before working inside your Embedded Box PC, read the safety information that shipped with your Embedded Box PC and follow the steps in [Before working inside your Embedded Box PC](#). After working inside your Embedded Box PC, follow the steps in [After working inside your Embedded Box PC](#). For more safety best practices, see the Regulatory Compliance home page at www.dell.com/regulatory_compliance.



CAUTION: Solid-state drives are fragile. Exercise care when handling the solid-state drive.

Procedure

- 1 Align the notch on the solid-state drive with the tab on the solid-state drive slot.
- 2 Slide the solid-state drive firmly into the slot and align the screw hole on the solid-state drive with the screw hole on the solid-state drive bracket
- 3 Replace the screw that secures the solid-state drive to the solid-state drive bracket.

Post-requisites

- 1 Replace the [drives in to the hard-drive cage](#).
- 2 Follow step 2 to step 8 in "[Replacing the back cover](#)".



Removing the interposer board



WARNING: Before working inside your Embedded Box PC, read the safety information that shipped with your Embedded Box PC and follow the steps in [Before working inside your Embedded Box PC](#). After working inside your Embedded Box PC, follow the steps in [After working inside your Embedded Box PC](#). For more safety best practices, see the Regulatory Compliance home page at www.dell.com/regulatory_compliance.

Prerequisites

- 1 Follow step 1 to step 6 in "[Removing the back cover](#)".
- 2 Remove the [drives from the hard-drive cage](#).
- 3 Remove the [solid-state drive from bracket](#).

Procedure

- 1 Remove the screws that secure the interposer board to the solid-state drive card bracket.

2 Lift the interposer board off the solid-state drive card bracket.

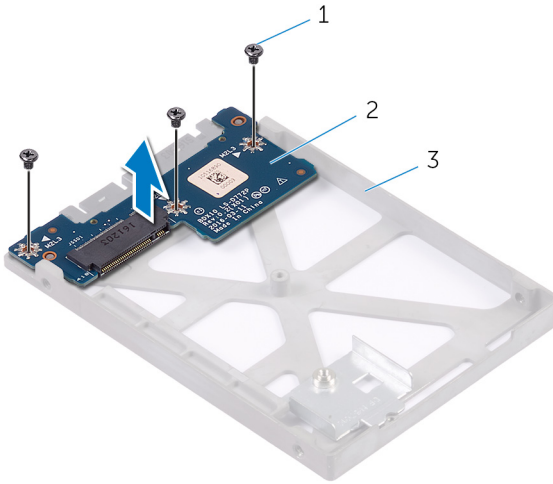

1 M2x3 screws (3)

2 interposer board

3 solid-state drive card bracket.



Replacing the interposer board



WARNING: Before working inside your Embedded Box PC, read the safety information that shipped with your Embedded Box PC and follow the steps in [Before working inside your Embedded Box PC](#). After working inside your Embedded Box PC, follow the steps in [After working inside your Embedded Box PC](#). For more safety best practices, see the Regulatory Compliance home page at www.dell.com/regulatory_compliance.

Procedure

- 1 Align the screw holes on the interposer board with the screw holes on the solid-state drive card bracket.
- 2 Replace the screws that secure the interposer board to the solid-state drive card bracket.

Post-requisites

- 1 Replace the [solid-state drive in to bracket](#).
- 2 Replace the [drives in to the hard-drive cage](#).
- 3 Follow step 2 to step 8 in "[Replacing the back cover](#)".

Installing a PCI/PCIe card

 **WARNING:** Before working inside your Embedded Box PC, read the safety information that shipped with your Embedded Box PC and follow the steps in [Before working inside your Embedded Box PC](#). After working inside your Embedded Box PC, follow the steps in [After working inside your Embedded Box PC](#). For more safety best practices, see the Regulatory Compliance home page at www.dell.com/regulatory_compliance.

 **CAUTION:** PCI/PCIe cards are fragile. Exercise care when handling the cards.

Prerequisites

Follow step 1 to step 6 in "[Removing the back cover](#)".



Procedure

Follow these steps to install a PCI or PCIe card into an empty PCI/PCIe card slot.

- 1 Remove the screws that secure the PCI/PCIe filler plate to the top cover.

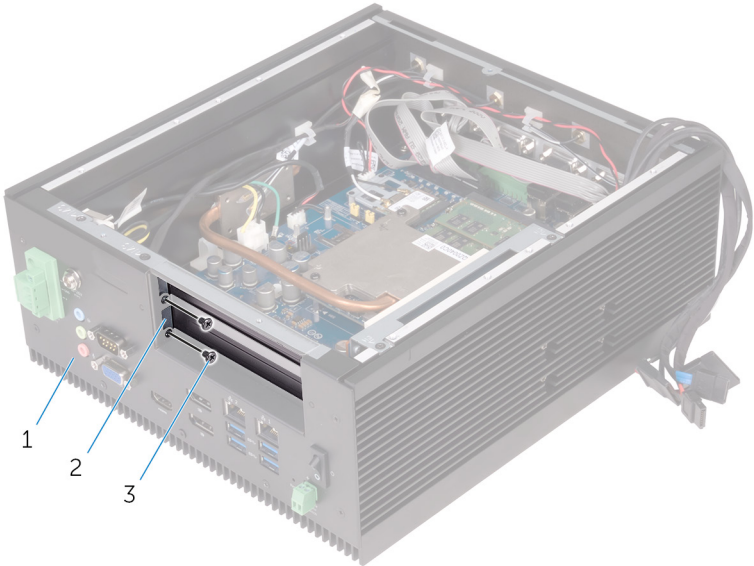

- | | | | |
|---|-----------------------------|---|-----------------------|
| 1 | chassis | 2 | PCI/PCIe filler plate |
| 3 | M3x5 countersunk screws (2) | | |

- 2 Remove the screws that secure the PCI/PCIe filler-plate bracket to the chassis.
- 3 Remove the bracket from the chassis.

- 4 Remove the filler plate from the chassis.

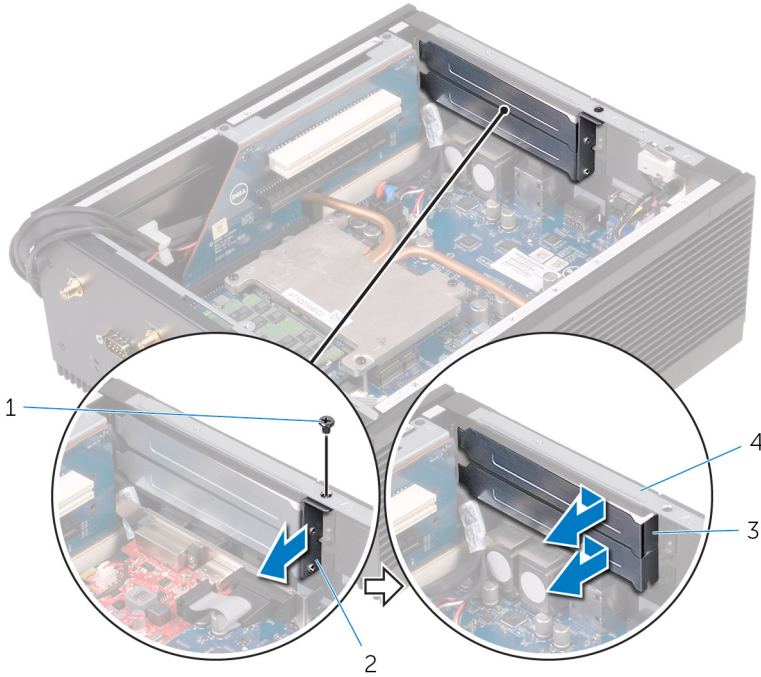

- 1 M3x5 countersunk screw
3 filler plate

- 2 PCI/PCIe filler-plate bracket
4 chassis



- 5** Install the PCIe or PCI cards in their respective slots on the riser board.

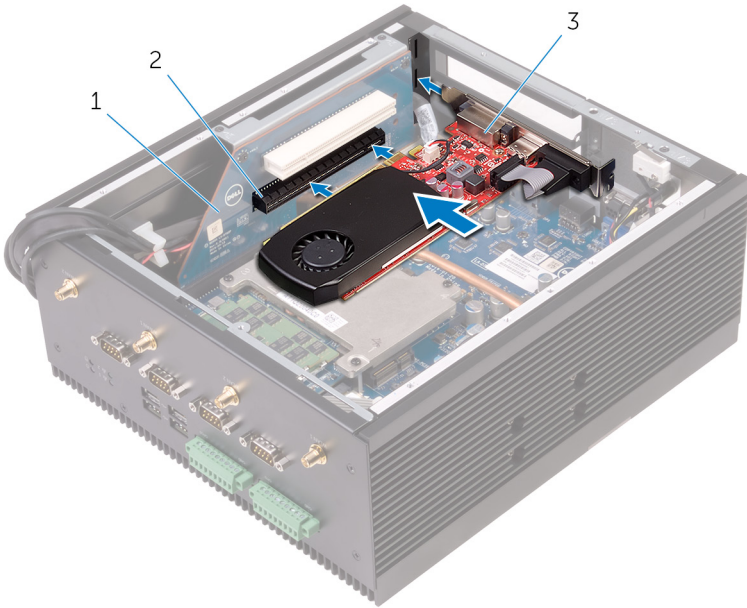

1 riser card

2 PCIe card slot

3 PCIe card

- 6** Replace the filler plate for an empty card slot.
7 Replace the filler-plate bracket on the chassis.

8 Replace the screw that secures the bracket to the chassis.

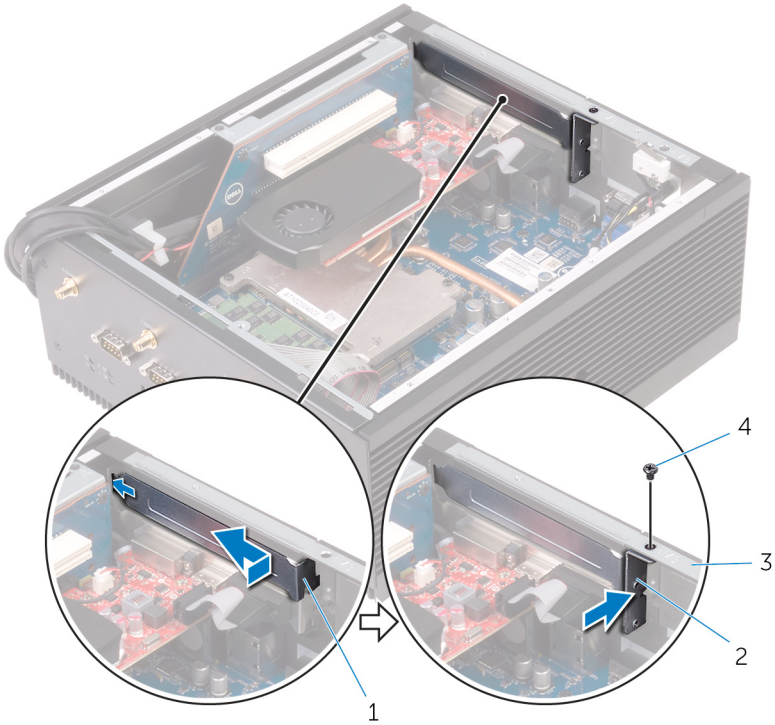

- 1 filler bracket
- 3 chassis

- 2 bracket
- 4 M3x5 countersunk screw



- 9 Replace the screws that secure the PCIe card and the filler plate to the chassis.

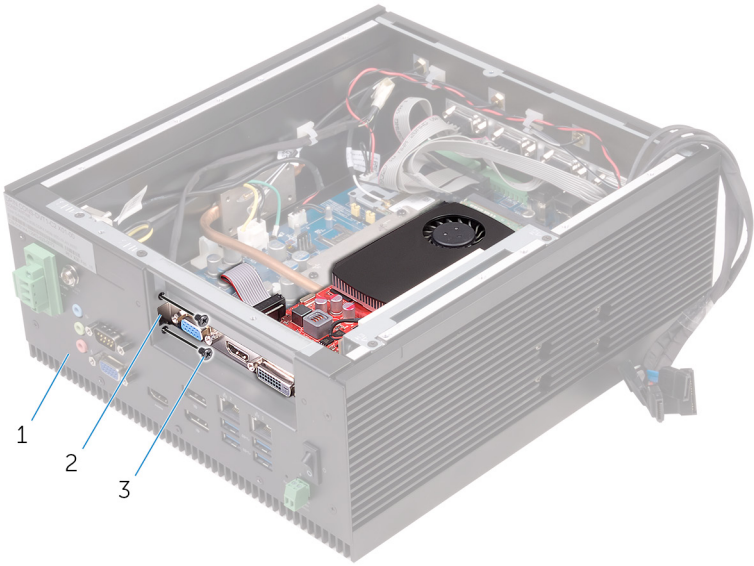

- | | | | |
|---|-----------------------------|---|--------------|
| 1 | chassis | 2 | filler plate |
| 3 | M3x5 countersunk screws (2) | | |

Post-requisites

Follow step 2 to step 8 in [“Replacing the back cover”](#).

Removing the PCI/PCIe card



WARNING: Before working inside your Embedded Box PC, read the safety information that shipped with your Embedded Box PC and follow the steps in [Before working inside your Embedded Box PC](#). After working inside your Embedded Box PC, follow the steps in [After working inside your Embedded Box PC](#). For more safety best practices, see the Regulatory Compliance home page at www.dell.com/regulatory_compliance.

Prerequisites

Follow step 1 to step 6 in "[Removing the back cover](#)".



Procedure

- 1 Remove the screws that secure PCI/PCIe cards to the chassis.

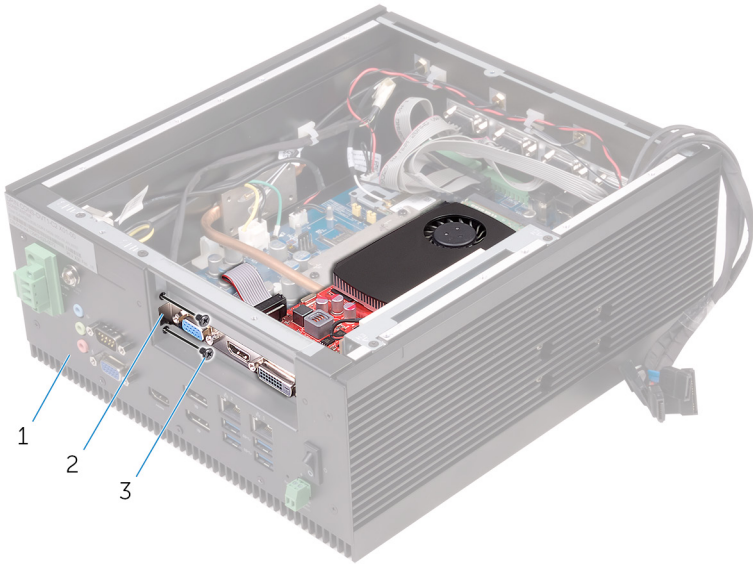

- | | | | |
|---|-----------------------------|---|-----------|
| 1 | chassis | 2 | PCIe card |
| 3 | M3x5 countersunk screws (2) | | |

- 2 Remove the screws that secure the PCI/PCIe filler-plate bracket to the chassis.
- 3 Remove the bracket from the chassis.

4 Remove the filler-plate from the chassis.

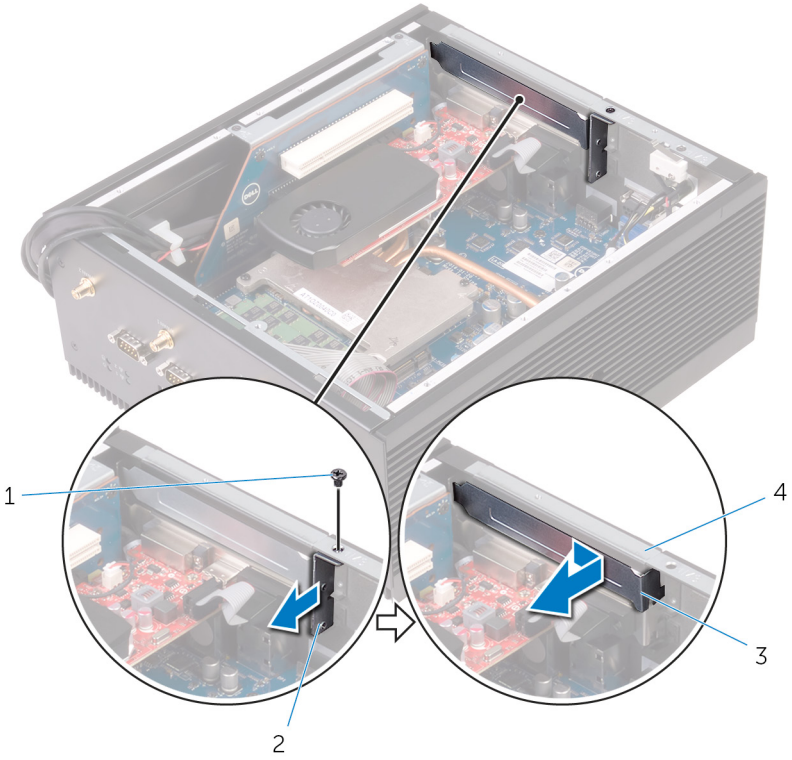

- 1 M3x5 countersunk screw
- 3 filler plate

- 2 bracket
- 4 chassis



- 5** Release the PCI/PCIe card from the PCI/PCIe card slot on the riser card and lift it off the chassis.

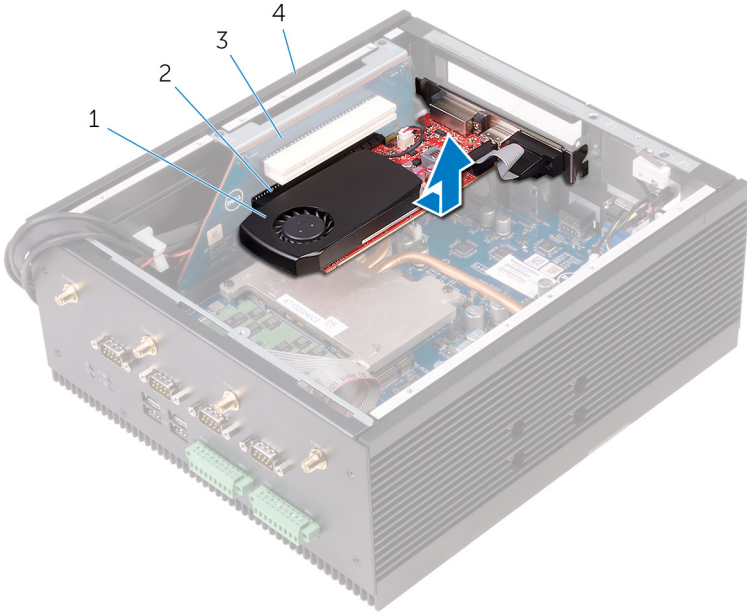

- 1 PCIe card
- 3 riser card

- 2 PCIe card-slot
- 4 chassis

Replacing the PCIe card

⚠ WARNING: Before working inside your Embedded Box PC, read the safety information that shipped with your Embedded Box PC and follow the steps in [Before working inside your Embedded Box PC](#). After working inside your Embedded Box PC, follow the steps in [After working inside your Embedded Box PC](#). For more safety best practices, see the Regulatory Compliance home page at www.dell.com/regulatory_compliance.

Procedure

- 1 Install the PCI/PCIe cards in their respective slots on the riser board.

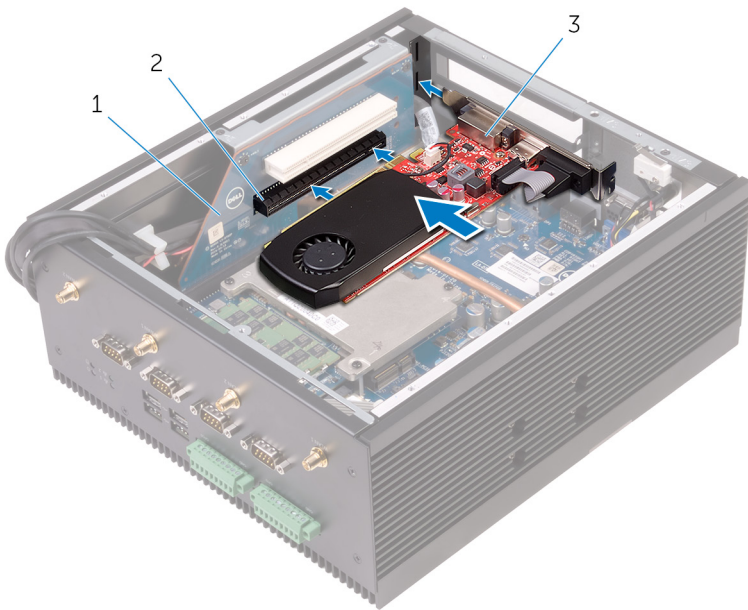

- 1 riser card
- 2 PCIe-card slot
- 3 PCIe card



- 2 Replace the filler plate for an empty card slot.
- 3 Replace the bracket on the chassis.
- 4 Replace the screw that secures the bracket to the chassis.

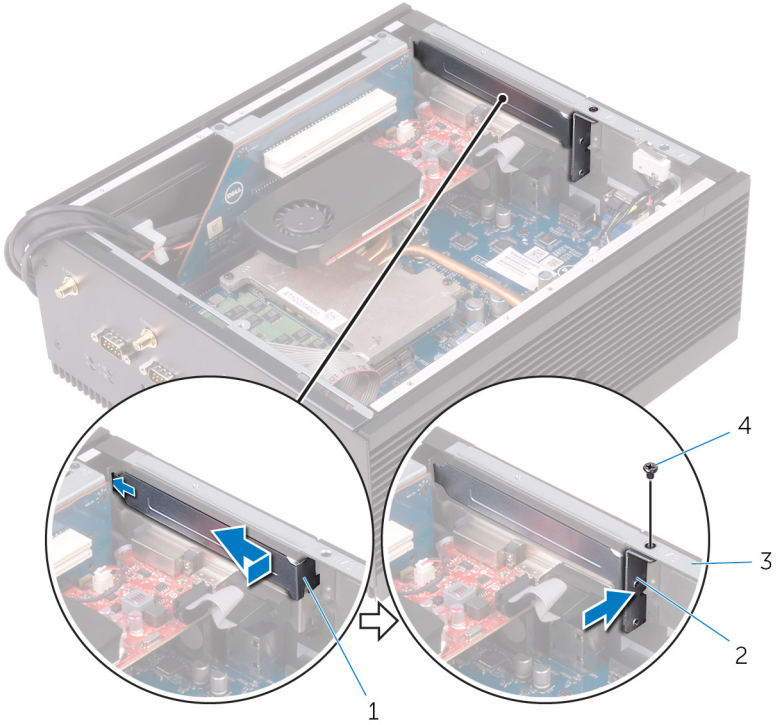

- 1 filler plate
- 3 chassis

- 2 filler-plate bracket
- 4 M3x5 countersunk screw

- 5 Replace the screws that secure the PCI/PCIe card and the filler plate to the chassis.

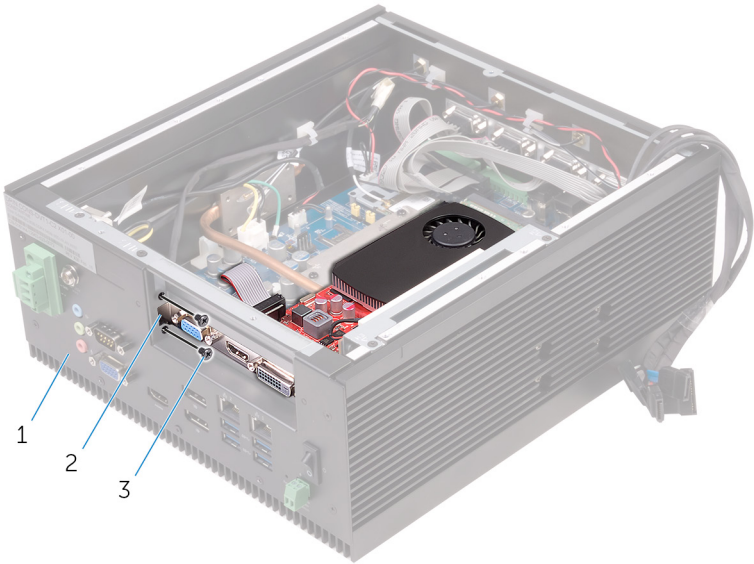

- | | | | |
|---|-----------------------------|---|--------------|
| 1 | chassis | 2 | filler plate |
| 3 | M3x5 countersunk screws (2) | | |

Post-requisites

Follow step 2 to step 8 in [“Replacing the back cover”](#).



Removing the memory module



WARNING: Before working inside your Embedded Box PC, read the safety information that shipped with your Embedded Box PC and follow the steps in [Before working inside your Embedded Box PC](#). After working inside your Embedded Box PC, follow the steps in [After working inside your Embedded Box PC](#). For more safety best practices, see the Regulatory Compliance home page at www.dell.com/regulatory_compliance.

Prerequisites

- 1 Follow step 1 to step 6 in "[Removing the back cover](#)".
- 2 Remove the [PCI/PCIe card](#) (if installed).

Procedure

- 1 Use your fingertips to carefully spread apart the securing-clips on each end of the memory-module slot until the memory module pops up.

2 Remove the memory module from the memory-module slot.

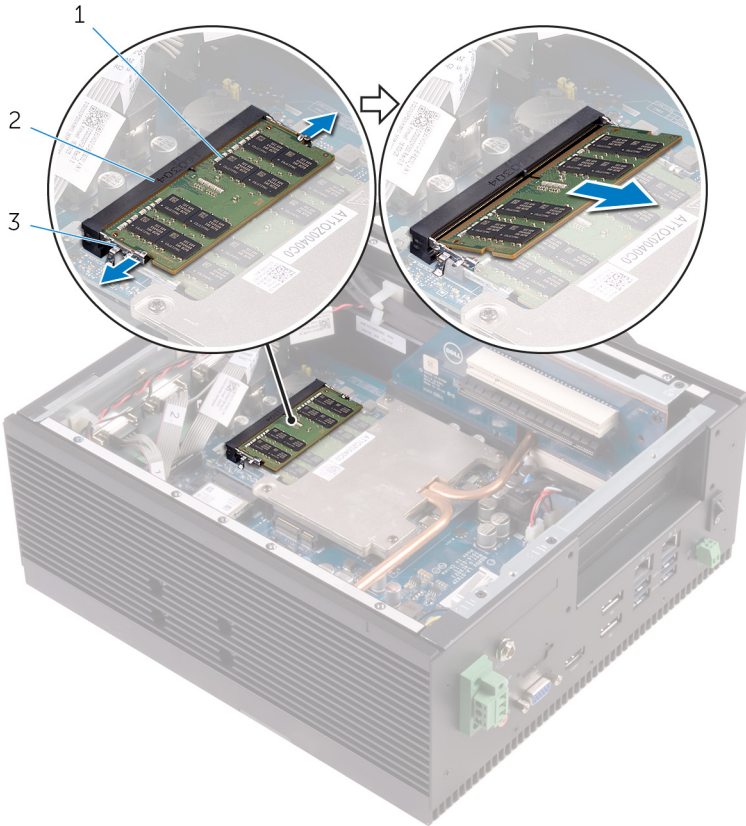

- 1 memory module
- 3 securing clips (2)

- 2 memory-module slot



Replacing the memory module



WARNING: Before working inside your Embedded Box PC, read the safety information that shipped with your Embedded Box PC and follow the steps in [Before working inside your Embedded Box PC](#). After working inside your Embedded Box PC, follow the steps in [After working inside your Embedded Box PC](#). For more safety best practices, see the Regulatory Compliance home page at www.dell.com/regulatory_compliance.

Procedure

- 1 Align the notch on the memory module with the tab on the memory-module slot.

- 2 Slide the memory module firmly into the slot at an angle and press the memory module down until it clicks into place.

 **NOTE: If you do not hear the click, remove the memory module and reinstall it.**

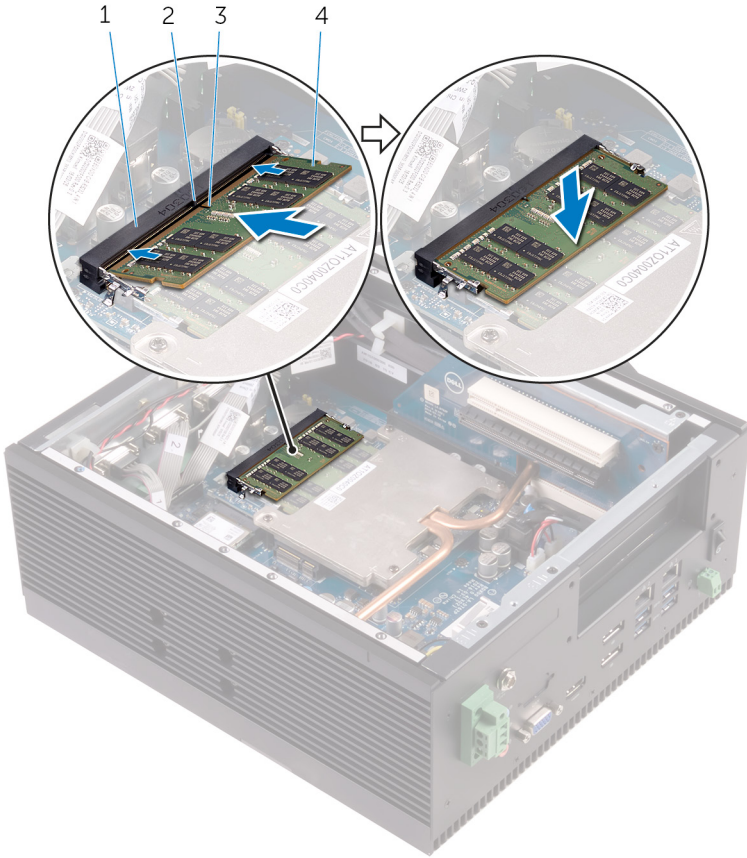

- 1 memory-module slot
3 notch

- 2 tab
4 memory module



Post-requisites

- 1 Replace the [PCI/PCIe card](#) (if necessary).
- 2 Follow step 2 to step 8 in "[Replacing the back cover](#)".



Removing the WLAN-antenna connectors



WARNING: Before working inside your Embedded Box PC, read the safety information that shipped with your Embedded Box PC and follow the steps in [Before working inside your Embedded Box PC](#). After working inside your Embedded Box PC, follow the steps in [After working inside your Embedded Box PC](#). For more safety best practices, see the Regulatory Compliance home page at www.dell.com/regulatory_compliance.

Prerequisites

- 1 Follow step 1 to step 6 in "[Removing the back cover](#)".
- 2 Remove the [PCI/PCIe card](#) (if installed).

Procedure

- 1 Remove the nuts and washers that secure the WLAN-antenna connectors one and two to the chassis.



- 2 Push the WLAN-antenna connectors through the chassis.

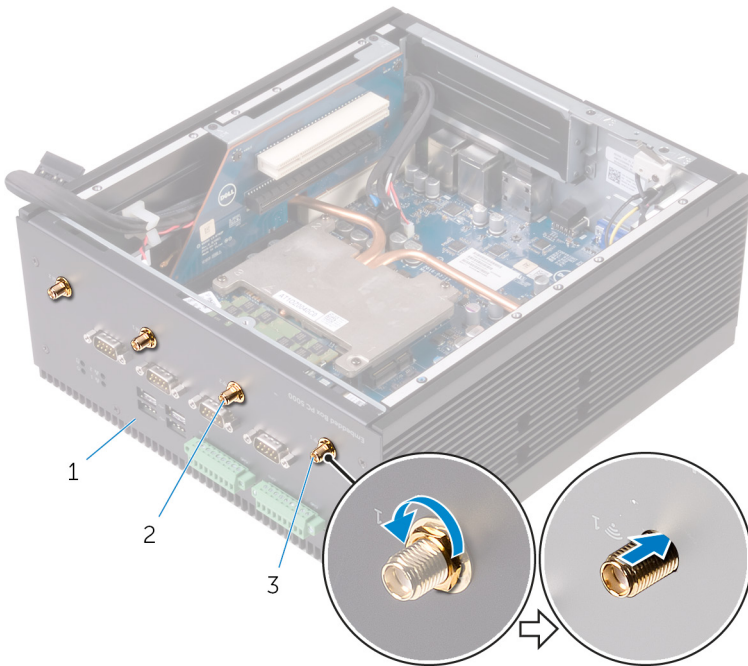

1 chassis

2 WLAN-antenna connectors
two

3 WLAN-antenna connectors
one

- 3 Disconnect the antenna cables from the WLAN card.
- 4 Remove the WLAN-antenna cables from the WLAN-cable routing guides on the chassis.

5 Remove the WLAN-antenna cable off the chassis.

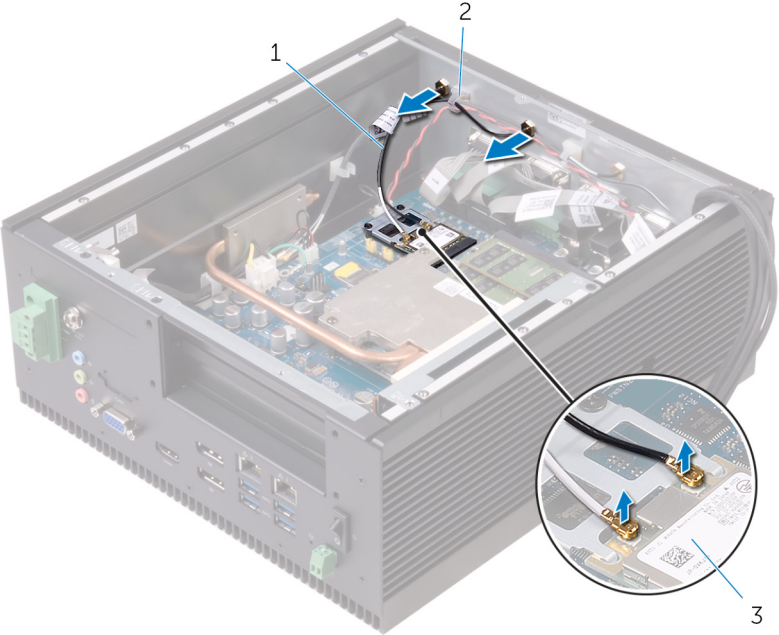

- 1 antenna cables
- 3 WLAN card

2 routing guide



Replacing the WLAN-antenna connectors



WARNING: Before working inside your Embedded Box PC, read the safety information that shipped with your Embedded Box PC and follow the steps in [Before working inside your Embedded Box PC](#). After working inside your Embedded Box PC, follow the steps in [After working inside your Embedded Box PC](#). For more safety best practices, see the Regulatory Compliance home page at www.dell.com/regulatory_compliance.

Procedure

- 1 Insert the WLAN-antenna connectors into the WLAN-antenna connector slots on the bottom cover.



NOTE: Insert the WLAN-antenna connectors based on the color indicated behind the bottom cover.

- 2 Replace the nuts and washers that secure the WLAN-antenna connectors to the bottom cover.
- 3 Route the WLAN-antenna cables through the routing guides on the chassis.
- 4 Connect the WLAN-antenna cables to the WLAN card.

The following table provides the antenna-cable color scheme for the WLAN card supported by the Embedded Box PC.

Connectors on the WLAN card	Antenna-cable color
Main (white triangle)	White
Auxiliary (black triangle)	Black

Post-requisites

- 1 Replace the [PCI/PCIe card](#) (if necessary).
- 2 Follow step 2 to step 8 in "[Replacing the back cover](#)".

Removing the WLAN card



WARNING: Before working inside your Embedded Box PC, read the safety information that shipped with your Embedded Box PC and follow the steps in [Before working inside your Embedded Box PC](#). After working inside your Embedded Box PC, follow the steps in [After working inside your Embedded Box PC](#). For more safety best practices, see the Regulatory Compliance home page at www.dell.com/regulatory_compliance.

Prerequisites

- 1 Follow step 1 to step 6 in "[Removing the back cover](#)".
- 2 Remove the [PCI/PCIe card](#) (if installed).

Procedure

- 1 Disconnect the antenna cables connected to the WLAN card.
- 2 Remove the screws that secure the WLAN-card bracket to the system board.
- 3 Remove the WLAN-card bracket from the WLAN card.



- 4 Slide and remove the WLAN card from the mPCIe2 slot.

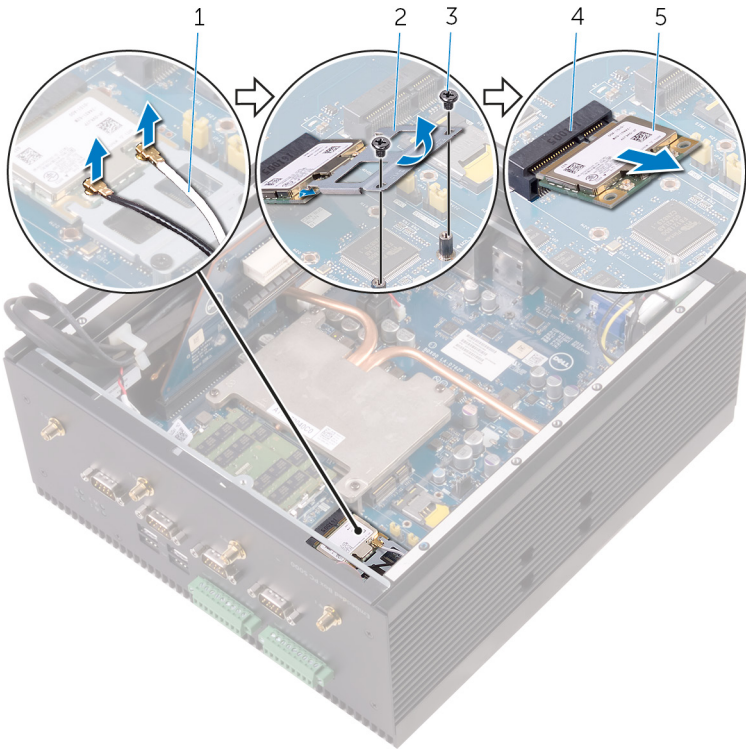

- | | | | |
|---|-------------------------|---|-------------------|
| 1 | WLAN-antenna cables (2) | 2 | WLAN-card bracket |
| 3 | M2x3 screws (2) | 4 | mPCIe2 slot |
| 5 | WLAN card | | |

Replacing the WLAN card



WARNING: Before working inside your Embedded Box PC, read the safety information that shipped with your Embedded Box PC and follow the steps in [Before working inside your Embedded Box PC](#). After working inside your Embedded Box PC, follow the steps in [After working inside your Embedded Box PC](#). For more safety best practices, see the Regulatory Compliance home page at www.dell.com/regulatory_compliance.

Procedure



NOTE: To avoid damage to the WLAN card, do not place any cables under it.

- 1 Align the notch on the WLAN card with the tab on the mPCIExpress slot.
- 2 Insert the WLAN card at an angle into the mPCIExpress slot.
- 3 Insert the WLAN-card bracket into the WLAN card.
- 4 Align the screw holes on the WLAN-card bracket with the screw holes on the system board.
- 5 Replace the screws that secure the WLAN-card bracket to the system board.



6 Connect the antenna cables to the WLAN card.

The following table provides the antenna-cable color scheme for the WLAN card supported by the Embedded Box PC.

Connectors on the WLAN card	Antenna-cable color
Main (white triangle)	White
Auxiliary (black triangle)	Black

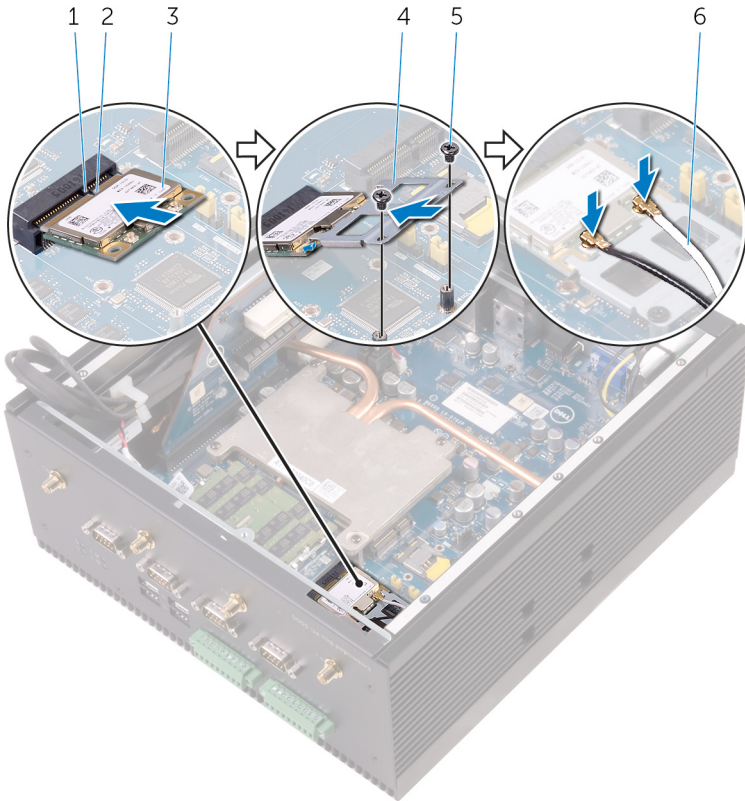

- 1 tab
- 2 notch
- 3 WLAN card
- 5 M2x3 screws (2)

- 4 WLAN-card bracket
- 6 WLAN-antenna cables (2)

Post-requisites

- 1 Replace the [PCI/PCIe card](#) (if necessary).
- 2 Follow step 2 to step 8 in "[Replacing the back cover](#)".



Removing the WWAN-antenna connectors



WARNING: Before working inside your Embedded Box PC, read the safety information that shipped with your Embedded Box PC and follow the steps in [Before working inside your Embedded Box PC](#). After working inside your Embedded Box PC, follow the steps in [After working inside your Embedded Box PC](#). For more safety best practices, see the Regulatory Compliance home page at www.dell.com/regulatory_compliance.

Prerequisites

- 1 Follow step 1 to step 6 in "[Removing the back cover](#)".
- 2 Remove the [PCI/PCIe card](#) (if installed).

Procedure

- 1 Remove the nuts and washers that secure the WWAN-antenna connectors one and two to the chassis.

- 2 Push the WWAN-antenna connectors through the chassis.

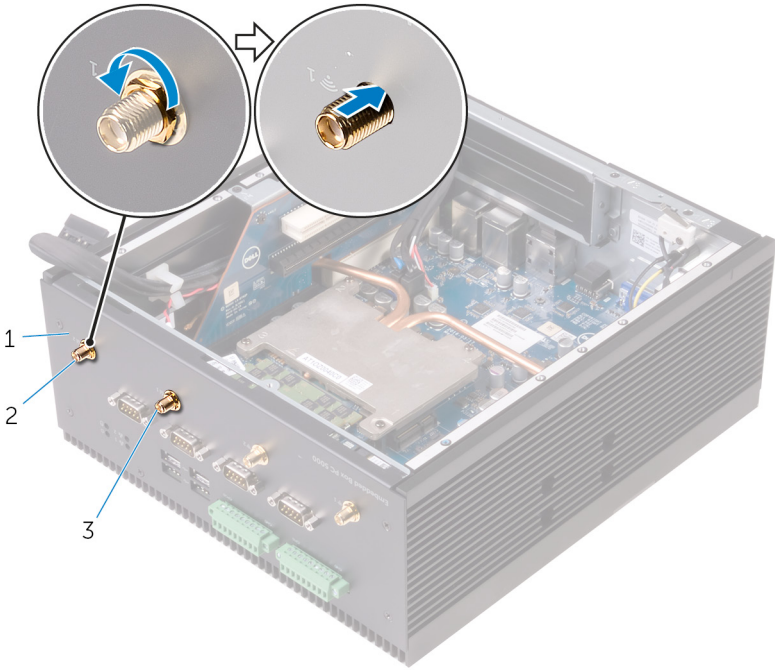

1 chassis

2 WWAN-antenna connector two

3 WWAN-antenna connector one

- 3 Disconnect the antenna cables from the WWAN card.
- 4 Remove the WWAN-antenna cables from the WWAN-cable routing guides on the chassis.



5 Remove the WLAN-antenna cable off the chassis.

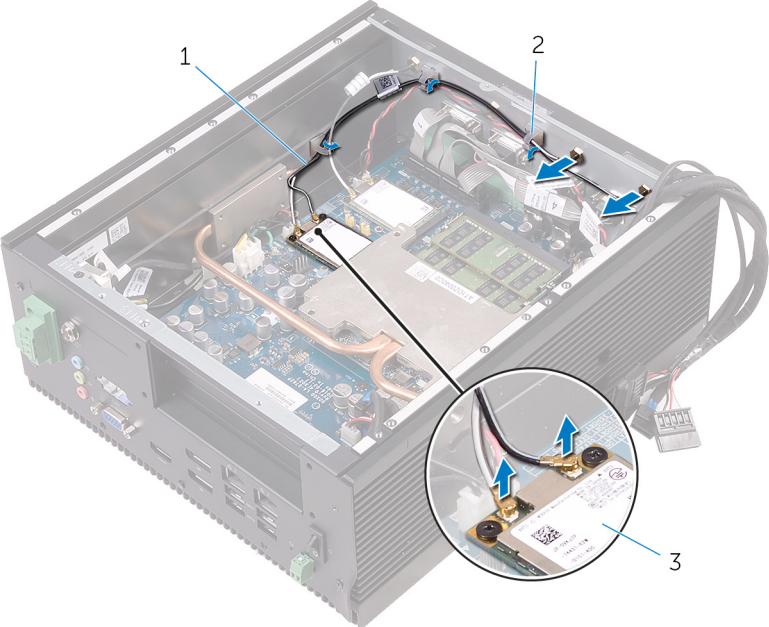

- 1 WWAN-antenna cables (2)
- 2 routing guide
- 3 WWAN card



Replacing the WWAN-antenna connectors



WARNING: Before working inside your Embedded Box PC, read the safety information that shipped with your Embedded Box PC and follow the steps in [Before working inside your Embedded Box PC](#). After working inside your Embedded Box PC, follow the steps in [After working inside your Embedded Box PC](#). For more safety best practices, see the Regulatory Compliance home page at www.dell.com/regulatory_compliance.

Procedure

- 1 Insert the WWAN-antenna connectors into the WWAN-antenna connector slots on the bottom cover.



NOTE: Insert the WWAN-antenna connectors based on the color indicated behind the bottom cover.

- 2 Replace the nuts and washers that secure the WWAN-antenna connectors to the bottom cover.
- 3 Route the WWAN-antenna cables through the routing guides on the chassis.
- 4 Connect the WWAN-antenna cables to the WWAN card.

The following table provides the antenna-cable color scheme for the WWAN card supported by the Embedded Box PC.

Connectors on the WWAN card	Antenna-cable color
Main (white triangle)	White/gray
Auxiliary (black triangle)	Black/gray

Post-requisites

- 1 Replace the [PCI/PCIe card](#) (if necessary).
- 2 Follow step 2 to step 8 in "[Replacing the back cover](#)".



Removing the WWAN card



WARNING: Before working inside your Embedded Box PC, read the safety information that shipped with your Embedded Box PC and follow the steps in [Before working inside your Embedded Box PC](#). After working inside your Embedded Box PC, follow the steps in [After working inside your Embedded Box PC](#). For more safety best practices, see the Regulatory Compliance home page at www.dell.com/regulatory_compliance.

Prerequisites

- 1 Follow step 1 to step 6 in "[Removing the back cover](#)".
- 2 Remove the [PCI/PCIe card](#) (if installed).

Procedure

- 1 Disconnect the antenna cables connected to the WWAN card.
- 2 Remove the screws that secure the WWAN card to the system board.

3 Slide and remove the WWAN card from the mPCIe1 slot.

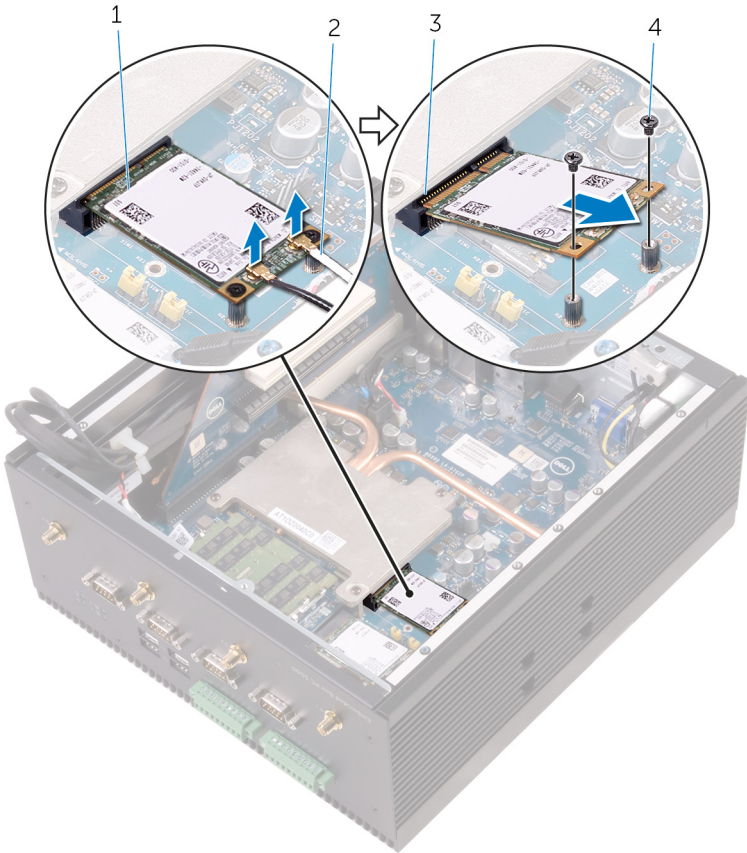

1 WWAN card

2 WWAN-antenna cables (2)

3 mPCIe1 slot

4 M2x3 screws (2)



Replacing the WWAN card



WARNING: Before working inside your Embedded Box PC, read the safety information that shipped with your Embedded Box PC and follow the steps in [Before working inside your Embedded Box PC](#). After working inside your Embedded Box PC, follow the steps in [After working inside your Embedded Box PC](#). For more safety best practices, see the Regulatory Compliance home page at www.dell.com/regulatory_compliance.

Procedure



NOTE: To avoid damage to the WWAN card, do not place any cables under it.

- 1 Align the notch on the WWAN card with the tab on the mPCIe1 slot.
- 2 Insert the WWAN card at an angle into the mPCIe1 slot.
- 3 Align the screw holes on the WWAN card with the screw holes on the system board.
- 4 Replace the screws that secure the WWAN card to the system board.

5 Connect the antenna cables to the WWAN card.

The following table provides the antenna-cable color scheme for the WWAN card supported by the Embedded Box PC.

Connectors on the WWAN card	Antenna-cable color
Main (white triangle)	White and gray
Auxiliary (black triangle)	Black and gray

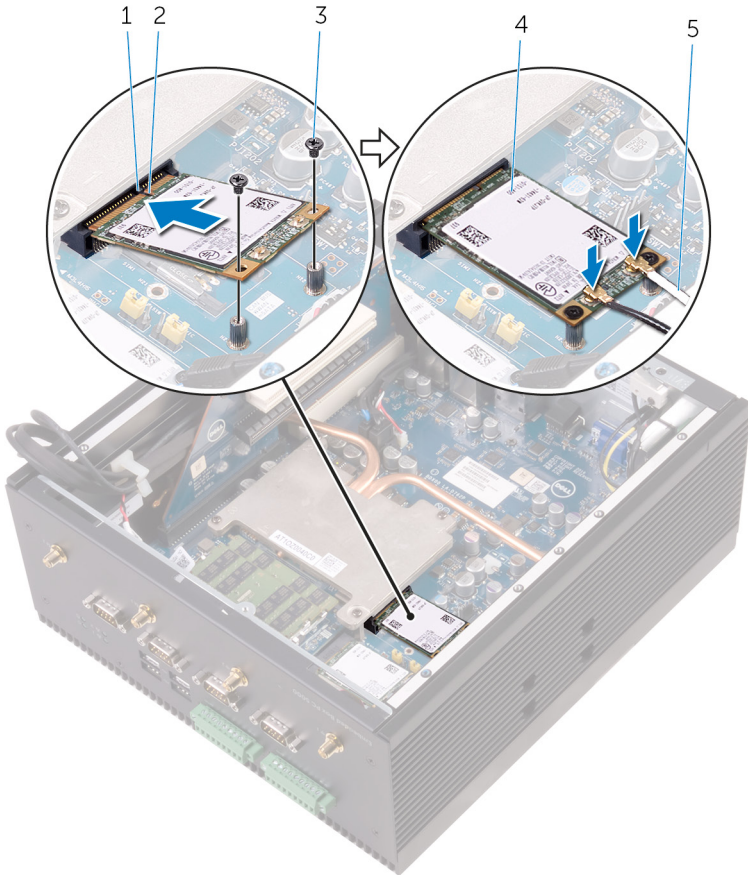

- | | | | |
|---|-------------------------|---|-----------|
| 1 | tab | 2 | notch |
| 3 | M2x3 screws (2) | 4 | WWAN card |
| 5 | WWAN-antenna cables (2) | | |



Post-requisites

- 1 Replace the [PCI/PCIe card](#) (if necessary).
- 2 Follow step 2 to step 8 in "[Replacing the back cover](#)".



Removing the SIM card



WARNING: Before working inside your Embedded Box PC, read the safety information that shipped with your Embedded Box PC and follow the steps in [Before working inside your Embedded Box PC](#). After working inside your Embedded Box PC, follow the steps in [After working inside your Embedded Box PC](#). For more safety best practices, see the Regulatory Compliance home page at www.dell.com/regulatory_compliance.

Prerequisites

- 1 Follow step 1 to step 6 in "[Removing the back cover](#)".
- 2 Remove the [WWAN card](#).

Procedure

- 1 Slide the SIM-card slot lock towards the mPCI-E1 connector, to release the SIM-card slot.
- 2 Open the SIM-card slot.



3 Remove the SIM card from the SIM-card slot.

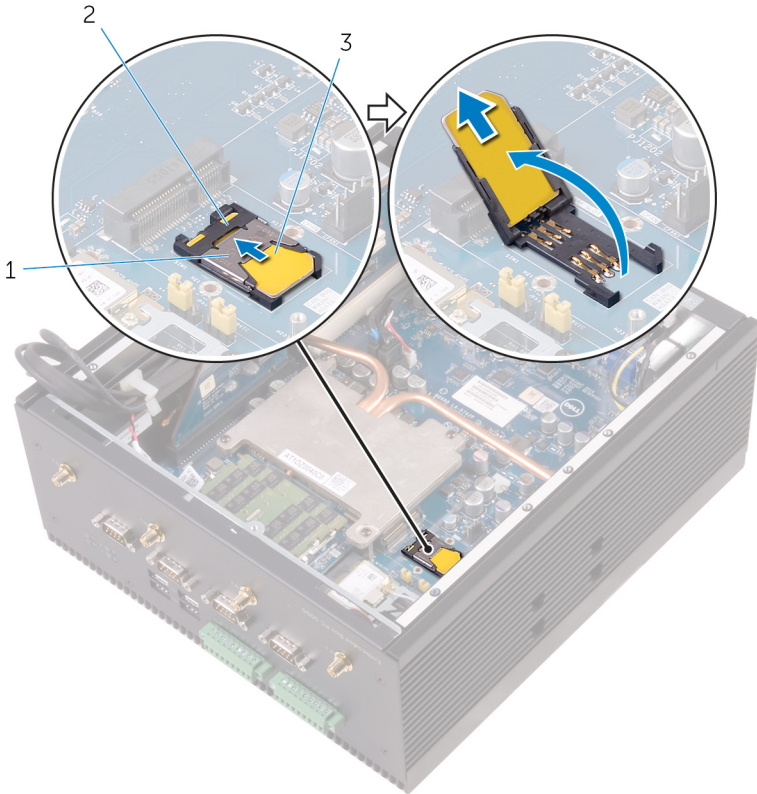

1 SIM-card slot lock

2 SIM-card slot

3 SIM card

Replacing the SIM card



WARNING: Before working inside your Embedded Box PC, read the safety information that shipped with your Embedded Box PC and follow the steps in [Before working inside your Embedded Box PC](#). After working inside your Embedded Box PC, follow the steps in [After working inside your Embedded Box PC](#). For more safety best practices, see the Regulatory Compliance home page at www.dell.com/regulatory_compliance.

Procedure

- 1 Place the SIM card into the SIM-card slot.
- 2 Close the SIM-card slot.



- 3 Slide the SIM-card slot lock sway from the mPCIE1 connector to secure the SIM-card slot.

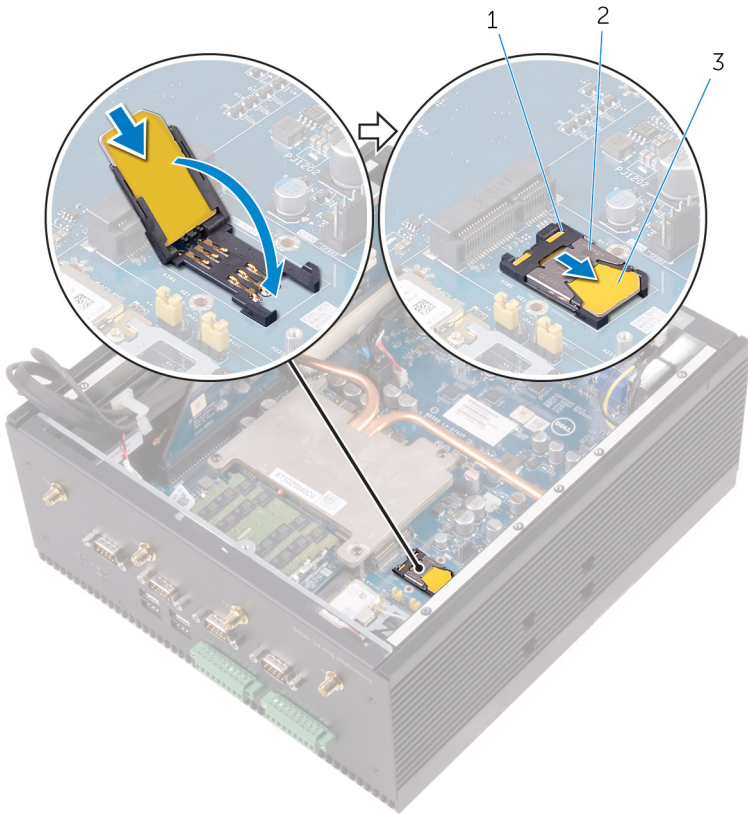

- 1 SIM-card slot
- 3 SIM-card

- 2 SIM-card slot lock

Post-requisites

- 1 Replace the [WWAN card](#).
- 2 Follow step 2 to step 8 in "[Replacing the back cover](#)".

Removing the CANbus cable



WARNING: Before working inside your Embedded Box PC, read the safety information that shipped with your Embedded Box PC and follow the steps in [Before working inside your Embedded Box PC](#). After working inside your Embedded Box PC, follow the steps in [After working inside your Embedded Box PC](#). For more safety best practices, see the Regulatory Compliance home page at www.dell.com/regulatory_compliance.

Prerequisites

- 1 Follow step 1 to step 6 in "[Removing the back cover](#)".
- 2 Remove the [PCI/PCIe card](#) (if installed).

Procedure

- 1 Disconnect the CANbus cable from the connector on the CANbus card.
- 2 Remove the CANbus cable from the routing guides on the chassis.
- 3 Slide the cable out from under the heat sink pipe.
- 4 Remove the hexagonal screws that secure the CANbus port to the top cover.



5 Lift the CANbus cable from the Embedded Box PC.

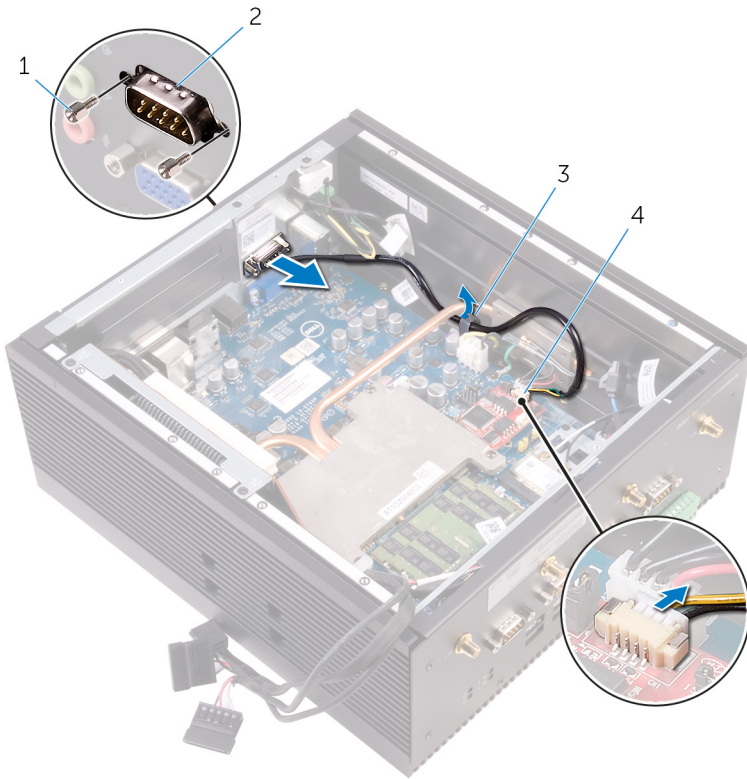

1 #4 40UNCx6.3 hexagonal screws (2)

3 routing guides

2 CANbus port

4 CANbus-cable connector

Replacing the CANbus cable



WARNING: Before working inside your Embedded Box PC, read the safety information that shipped with your Embedded Box PC and follow the steps in [Before working inside your Embedded Box PC](#). After working inside your Embedded Box PC, follow the steps in [After working inside your Embedded Box PC](#). For more safety best practices, see the Regulatory Compliance home page at www.dell.com/regulatory_compliance.

Procedure

- 1 Place the CANbus port into the CANbus slot on the top cover.
- 2 Replace the hexagonal screws that secure the CANbus port to the top cover.
- 3 Route the CANbus cable through the routing guides on the chassis and under the heat sink plate.
- 4 Connect the CANbus cable to the connector on the CANbus card.

Post-requisites

- 1 Replace the [PCI/PCIe card](#) (if necessary).
- 2 Follow step 2 to step 8 in [“Replacing the back cover”](#).



Removing the CANbus card



WARNING: Before working inside your Embedded Box PC, read the safety information that shipped with your Embedded Box PC and follow the steps in [Before working inside your Embedded Box PC](#). After working inside your Embedded Box PC, follow the steps in [After working inside your Embedded Box PC](#). For more safety best practices, see the Regulatory Compliance home page at www.dell.com/regulatory_compliance.

Prerequisites

- 1 Follow step 1 to step 6 in "[Removing the back cover](#)".
- 2 Remove the [PCI/PCle card](#) (if installed).

Procedure



NOTE: Embedded Box PC is shipped with a combination of WWAN, WLAN, or CANbus card depending on the configuration ordered.

- 1 Disconnect the CANbus cable from the connector on the CANbus card.
- 2 Remove the screws that secure the CANbus card to the system board.

3 Slide and remove the CANbus card from the mPCIe1 slot.

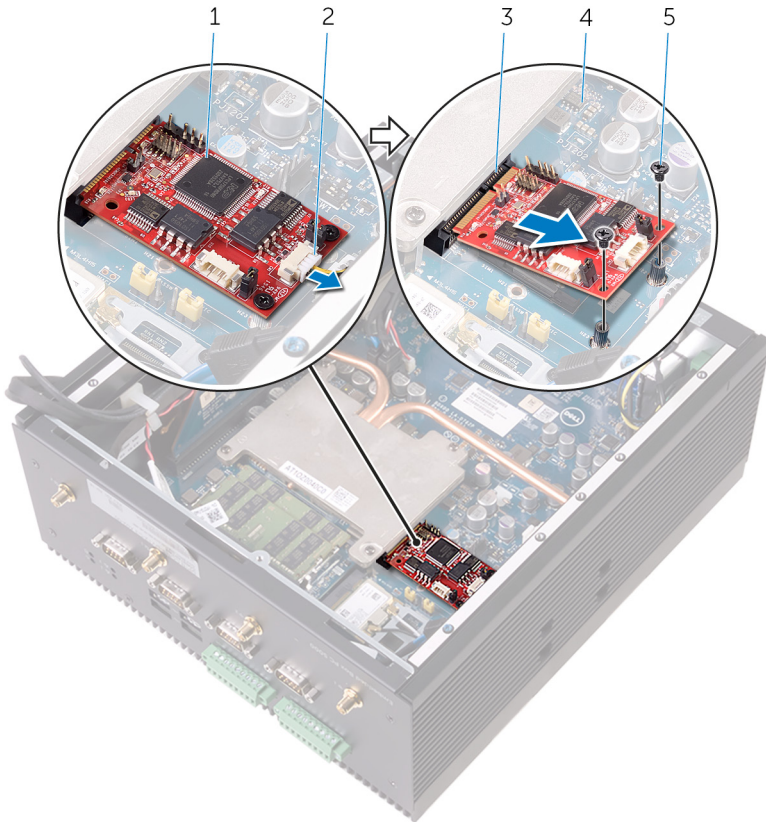

1 CANbus card

2 CANbus cable

3 mPCIe1 slot

4 system board

5 M2x3 screws (2)



Replacing the CANbus card



WARNING: Before working inside your Embedded Box PC, read the safety information that shipped with your Embedded Box PC and follow the steps in [Before working inside your Embedded Box PC](#). After working inside your Embedded Box PC, follow the steps in [After working inside your Embedded Box PC](#). For more safety best practices, see the Regulatory Compliance home page at www.dell.com/regulatory_compliance.

Procedure

- 1 Align the notch on the CANbus card with the tab on the mPCIe1 slot.
- 2 Insert the CANbus card at an angle into the mPCIe1 slot.
- 3 Align the screw holes on the CANbus card with the screw holes on the system board.
- 4 Replace the screws that secure the CANbus card to the system board.

- 5 Connect the CANbus cable to the connector on the CANbus card.

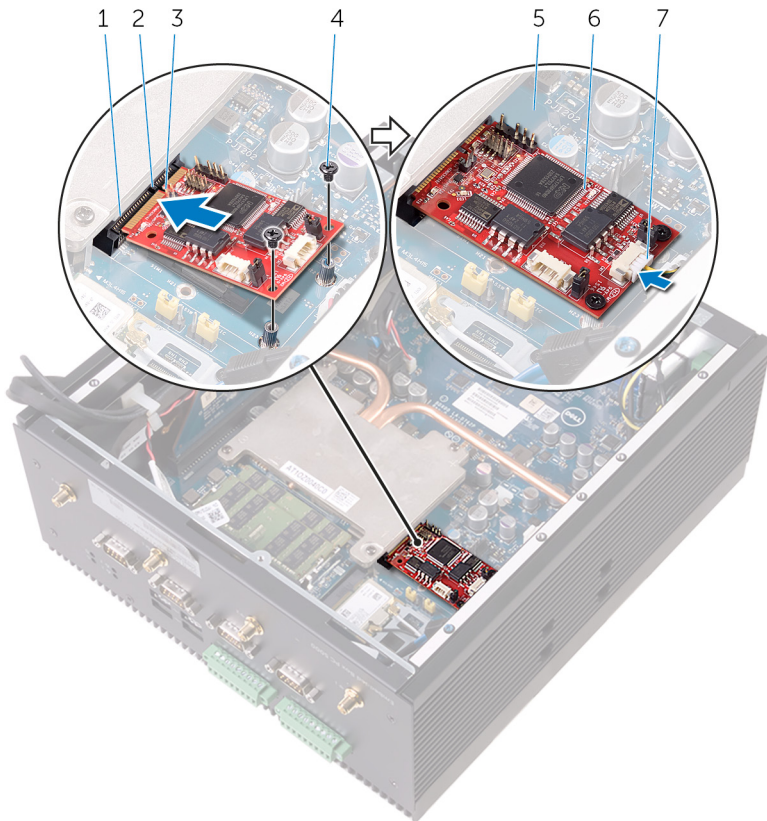

- | | | | |
|---|-------------------|---|-----------------|
| 1 | mPCIe1 slot | 2 | tab |
| 3 | notch | 4 | M2x3 screws (2) |
| 5 | system board | 6 | CANbus card |
| 7 | CANbus-card cable | | |

Post-requisites

- 1 Replace the [PCI/PCIe card](#) (if necessary).
- 2 Follow step 2 to step 8 in [“Replacing the back cover”](#).



Removing the coin-cell battery

 **WARNING:** Before working inside your Embedded Box PC, read the safety information that shipped with your Embedded Box PC and follow the steps in [Before working inside your Embedded Box PC](#). After working inside your Embedded Box PC, follow the steps in [After working inside your Embedded Box PC](#). For more safety best practices, see the Regulatory Compliance home page at www.dell.com/regulatory_compliance.

 **CAUTION:** Removing the coin-cell battery resets the BIOS setup program's settings to default. It is recommended that you note the BIOS setup program's settings before removing the coin-cell battery.

Prerequisites

- 1 Follow step 1 to step 6 in "[Removing the back cover](#)".
- 2 Remove the [PCI/PCIe card](#) (if installed).

Procedure

- 1 Using a plastic scribe, push the battery-release lever away from the coin-cell battery until the coin-cell battery pops up.

2 Lift the coin-cell battery out of its socket.

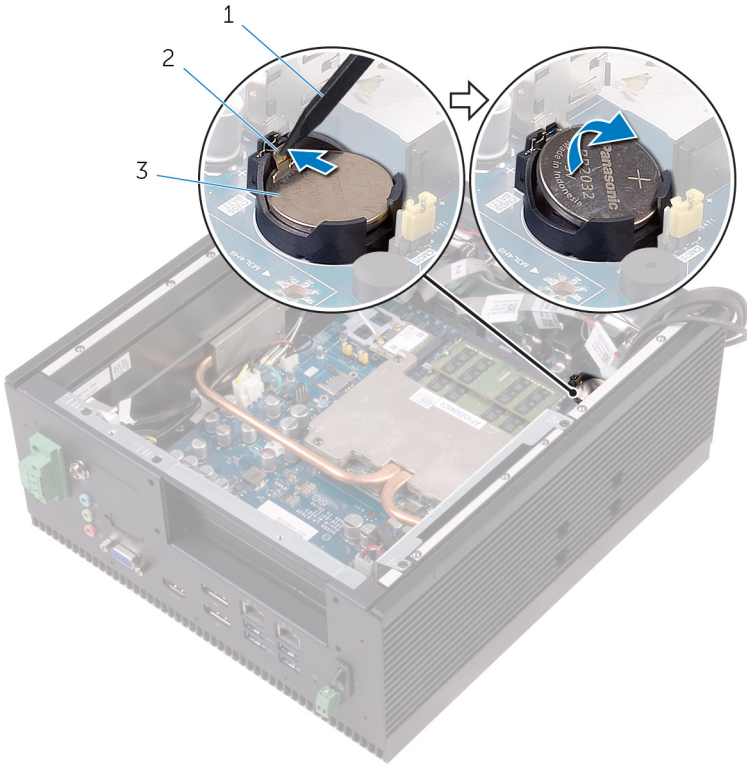

- 1 plastic scribe
- 3 coin-cell battery

2 battery-release lever



Replacing the coin-cell battery



WARNING: Before working inside your Embedded Box PC, read the safety information that shipped with your Embedded Box PC and follow the steps in [Before working inside your Embedded Box PC](#). After working inside your Embedded Box PC, follow the steps in [After working inside your Embedded Box PC](#). For more safety best practices, see the Regulatory Compliance home page at www.dell.com/regulatory_compliance.

Procedure

With the positive-side facing up, snap the coin-cell battery into the battery socket on the system board.

Post-requisites

- 1 Replace the [PCI/PCIe card](#) (if necessary).
- 2 Follow step 2 to step 8 in "[Replacing the back cover](#)".

Removing the intrusion switch



WARNING: Before working inside your Embedded Box PC, read the safety information that shipped with your Embedded Box PC and follow the steps in [Before working inside your Embedded Box PC](#). After working inside your Embedded Box PC, follow the steps in [After working inside your Embedded Box PC](#). For more safety best practices, see the Regulatory Compliance home page at www.dell.com/regulatory_compliance.

Prerequisites

- 1 Follow step 1 to step 6 in "[Removing the back cover](#)".
- 2 Remove the [PCI/PCIe card](#) (if installed).

Procedure

- 1 Disconnect the intrusion-switch cable from intrusion-switch connector on the system board.
- 2 Remove the intrusion-switch cable from the routing guides on the chassis.
- 3 Slide the cable out from under the heat sink pipe.
- 4 Remove the screw that secures the intrusion switch to the chassis.



5 Remove the intrusion switch from the chassis.

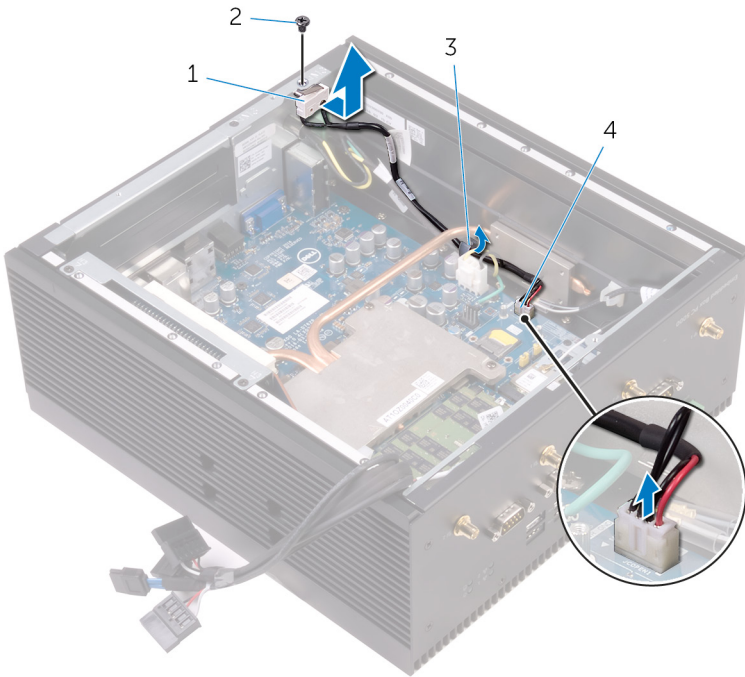

1 intrusion switch

2 M3x5 countersunk screw

3 routing guide

4 intrusion-switch cable

Replacing the intrusion switch



WARNING: Before working inside your Embedded Box PC, read the safety information that shipped with your Embedded Box PC and follow the steps in [Before working inside your Embedded Box PC](#). After working inside your Embedded Box PC, follow the steps in [After working inside your Embedded Box PC](#). For more safety best practices, see the Regulatory Compliance home page at www.dell.com/regulatory_compliance.

Procedure

- 1 Replace the screw that secures the intrusion switch to the chassis.
- 2 Route the intrusion-switch cable through the routing guides on the chassis and under the heat sink pipe.
- 3 Connect the intrusion-switch cable to the intrusion-switch connector on the system board.

Post-requisites

- 1 Replace the [PCI/PCIe card](#) (if necessary).
- 2 Follow step 2 to step 8 in "[Replacing the back cover](#)".



Removing the serial ports



WARNING: Before working inside your Embedded Box PC, read the safety information that shipped with your Embedded Box PC and follow the steps in [Before working inside your Embedded Box PC](#). After working inside your Embedded Box PC, follow the steps in [After working inside your Embedded Box PC](#). For more safety best practices, see the Regulatory Compliance home page at www.dell.com/regulatory_compliance.

Prerequisites

- 1 Follow step 1 to step 6 in "[Removing the back cover](#)".
- 2 Remove the [PCI/PCle card](#) (if installed).

Procedure

- 1 Remove the hexagonal screws that secure the serial ports to the bottom-cover.



- | | | | |
|---|-----------------------------------|---|------------------|
| 1 | chassis | 2 | serial ports (4) |
| 3 | #4 40UNCx6.3 hexagonal screws (8) | | |

- 2 Disconnect the serial-port cable from the connector on the system board.



- 3 Remove the serial-port cables from the bottom cover and lift it off the chassis.

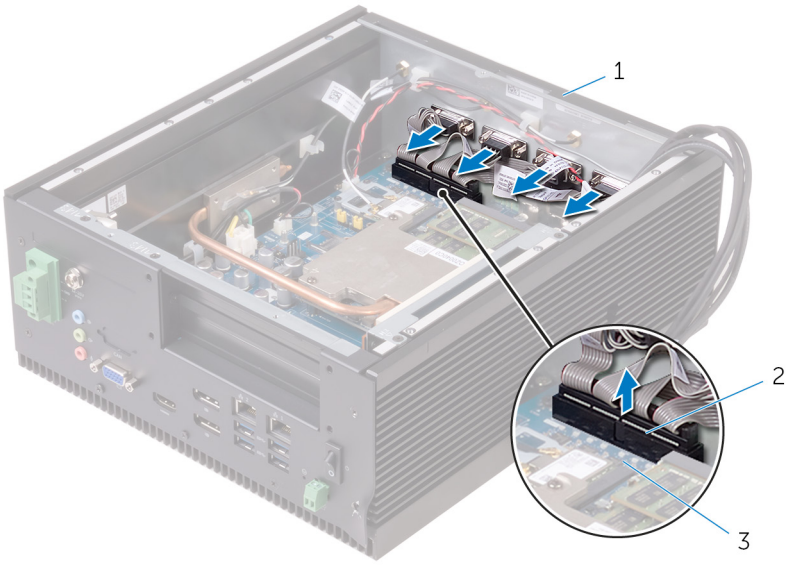

1 chassis

2 serial-port connector

3 system board

Replacing the serial ports



WARNING: Before working inside your Embedded Box PC, read the safety information that shipped with your Embedded Box PC and follow the steps in [Before working inside your Embedded Box PC](#). After working inside your Embedded Box PC, follow the steps in [After working inside your Embedded Box PC](#). For more safety best practices, see the Regulatory Compliance home page at www.dell.com/regulatory_compliance.

Procedure

- 1 Connect the serial-port cable to the connector on the system board.
- 2 Insert the serial ports into the respective slots on the bottom cover.
 -  **NOTE:** Match the port number with the number on the cable.
- 3 Replace the hexagonal screws that secure the serial ports to the bottom-cover.

Post-requisites

- 1 Replace the [PCI/PCIe card](#) (if necessary).
- 2 Follow step 2 to step 8 in [“Replacing the back cover”](#).



Removing the bottom cover



WARNING: Before working inside your Embedded Box PC, read the safety information that shipped with your Embedded Box PC and follow the steps in [Before working inside your Embedded Box PC](#). After working inside your Embedded Box PC, follow the steps in [After working inside your Embedded Box PC](#). For more safety best practices, see the Regulatory Compliance home page at www.dell.com/regulatory_compliance.

Prerequisites

- 1 Follow step 1 to step 6 in "[Removing the back cover](#)".
- 2 Remove the [PCI/PCIe card](#) (if installed).
- 3 Remove the [WWAN-antenna connectors](#).
- 4 Remove the [WLAN-antenna connectors](#).
- 5 Remove the [serial ports](#).

Procedure

- 1 Remove the screws that secure the top cover to the chassis.

2 Remove the top cover off the chassis.

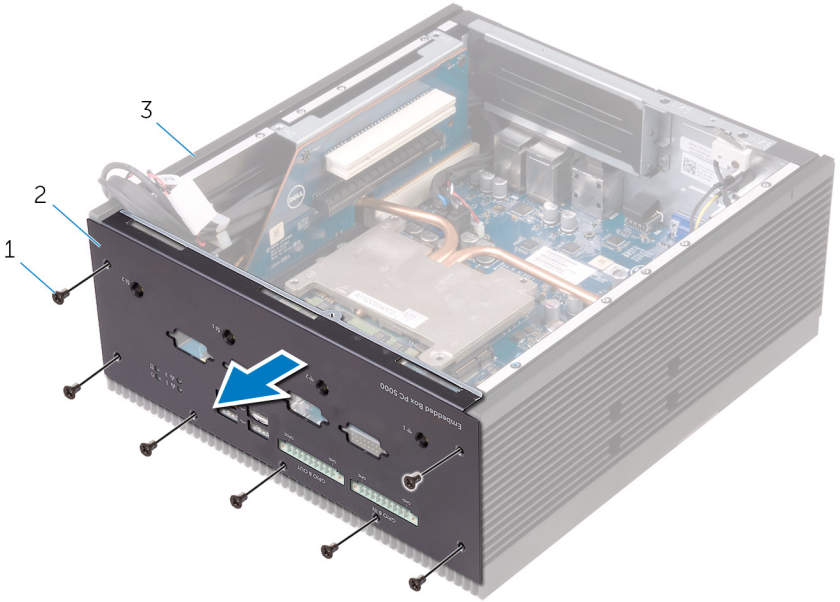

- 1 M3x5 countersunk screws (7)
- 2 bottom cover
- 3 chassis



Replacing the bottom cover



WARNING: Before working inside your Embedded Box PC, read the safety information that shipped with your Embedded Box PC and follow the steps in [Before working inside your Embedded Box PC](#). After working inside your Embedded Box PC, follow the steps in [After working inside your Embedded Box PC](#). For more safety best practices, see the Regulatory Compliance home page at www.dell.com/regulatory_compliance.

Procedure

- 1 Replace the [hard-drive cage](#).
- 2 Insert the tabs on back cover at an angle into the slots on the chassis.
- 3 Open the back cover.
- 4 Route the SATA-power and SATA-data cables through the routing guides.
- 5 Connect the SATA-power and SATA-data cable to the hard drive or solid-state drive assembly.



NOTE: Connect the cables to the second drive if installed.

- 6 Close the back cover.
- 7 Align the screw holes on the back cover with the screw holes on the chassis.
- 8 Replace screws that secure the back cover to the chassis.

Post-requisites

- 1 Replace the [serial port](#).
- 2 Replace the [WLAN-antenna connectors](#).
- 3 Replace the [WWAN-antenna connectors](#).
- 4 Replace the [PCI/PCIe card](#) (if necessary).
- 5 Follow step 2 to step 8 in "[Replacing the back cover](#)".

Removing the riser card



WARNING: Before working inside your Embedded Box PC, read the safety information that shipped with your Embedded Box PC and follow the steps in [Before working inside your Embedded Box PC](#). After working inside your Embedded Box PC, follow the steps in [After working inside your Embedded Box PC](#). For more safety best practices, see the Regulatory Compliance home page at www.dell.com/regulatory_compliance.

Prerequisites

- 1 Follow step 1 to step 6 in "[Removing the back cover](#)".
- 2 Remove the [PCI/PCle card](#) (if installed).

Procedure

- 1 Remove the screws that secure the riser card to the chassis.



2 Lift the riser card off the system board.

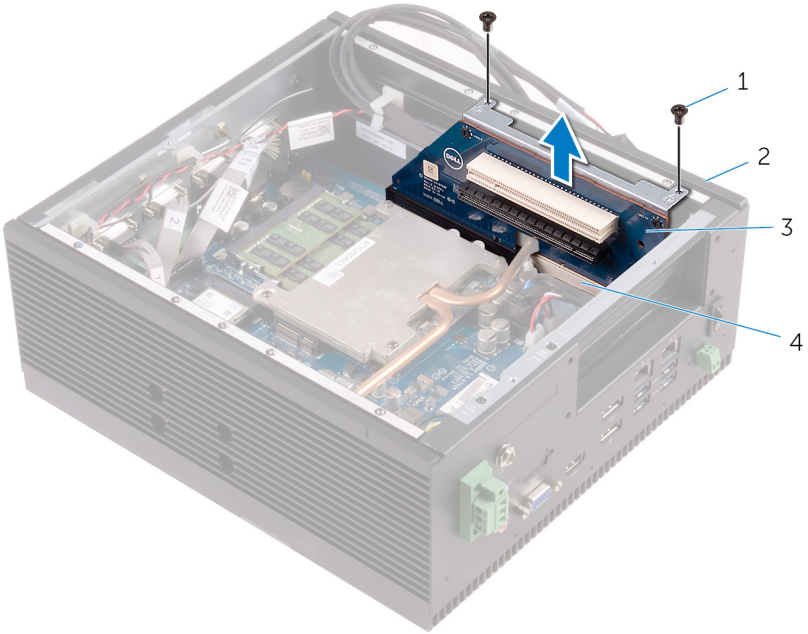

1 screws (2)

2 chassis

3 riser card

3 Remove the screws that secure the riser card to the riser-card bracket.

- 4 Remove the riser-card bracket from the riser card.

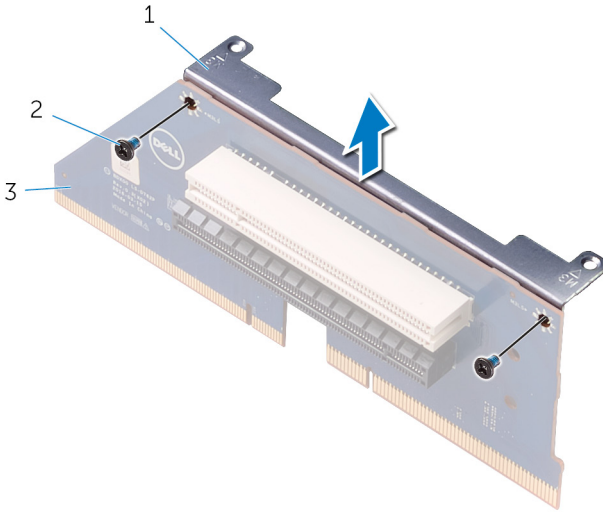

1 riser-card bracket

2 screws (2)

3 riser card



Replacing the riser card



WARNING: Before working inside your Embedded Box PC, read the safety information that shipped with your Embedded Box PC and follow the steps in [Before working inside your Embedded Box PC](#). After working inside your Embedded Box PC, follow the steps in [After working inside your Embedded Box PC](#). For more safety best practices, see the Regulatory Compliance home page at www.dell.com/regulatory_compliance.

Procedure

- 1 Align the screws holes on the riser-card bracket with the screw holes on the riser card.
- 2 Replace the screws that secure the riser-card bracket to the riser card.
- 3 Insert the riser card into the riser-card slots on the system board.
- 4 Align the screw holes on the riser-card with the screw holes on the chassis.
- 5 Replace the screws that secure the riser card to the chassis.

Post-requisites

- 1 Replace the [PCI/PCIe card](#) (if necessary).
- 2 Follow step 2 to step 8 in "[Replacing the back cover](#)".

Removing the heat sink



WARNING: Before working inside your Embedded Box PC, read the safety information that shipped with your Embedded Box PC and follow the steps in [Before working inside your Embedded Box PC](#). After working inside your Embedded Box PC, follow the steps in [After working inside your Embedded Box PC](#). For more safety best practices, see the Regulatory Compliance home page at www.dell.com/regulatory_compliance.

Prerequisites

- 1 Follow step 1 to step 6 in "[Removing the back cover](#)".
- 2 Remove the [PCI/PCIe card](#) (if installed).

Procedure

- 1 Remove the screws that secure the chassis heat-sinks to the sides of the chassis.
- 2 In sequential order (as indicated on the heat sink), remove the screws that secure the heatsink to the CPU board.



3 Lift the heat sink off the CPU board.

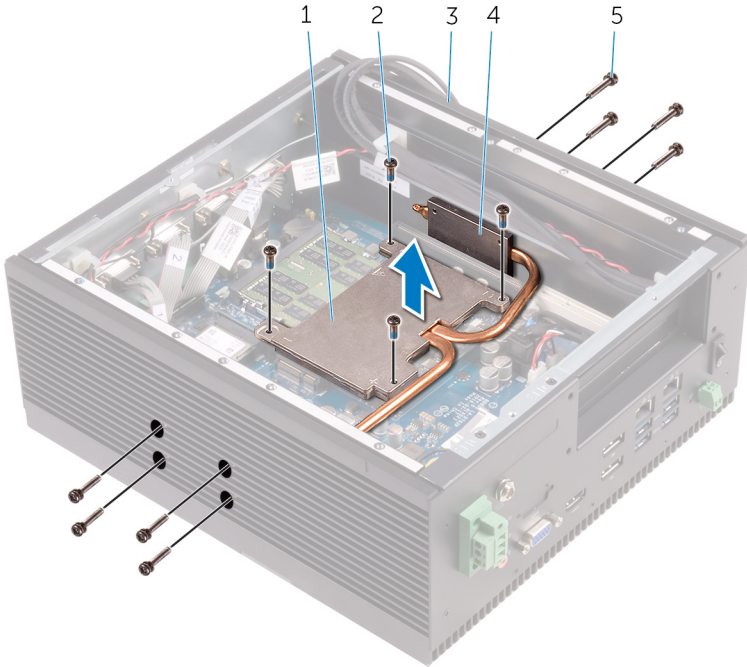

1 heat sink

3 chassis

5 M3x16 chassis heat-sink screws (8)

2 M3x8 heat sink screws (4)

4 chassis heat-sink (2)

Replacing the heat sink

⚠ WARNING: Before working inside your Embedded Box PC, read the safety information that shipped with your Embedded Box PC and follow the steps in [Before working inside your Embedded Box PC](#). After working inside your Embedded Box PC, follow the steps in [After working inside your Embedded Box PC](#). For more safety best practices, see the Regulatory Compliance home page at www.dell.com/regulatory_compliance.

Procedure

- 1 Replace the thermal pads on the heat sink.

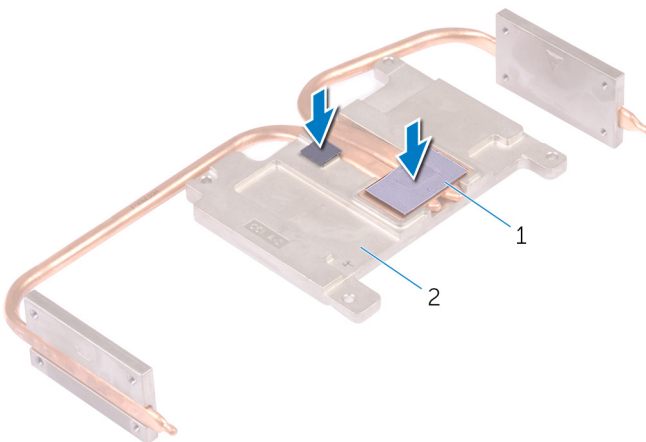

- 2 Place the heat sink on the CPU board.
- 3 Align the screw holes on the heat sink with the screw holes on the CPU board.
- 4 In sequential order (indicated on the heat sink), replace the screws that secure the heat sink to the CPU board.
- 5 Replace the screws that secure the chassis heat-sinks to the sides of the chassis.



Post-requisites

- 1 Replace the [riser card](#).
- 2 Replace the [PCI/PCle card](#) (if necessary).
- 3 Follow step 2 to step 9 in replacing the "[back cover](#)".



Removing the power connectors



WARNING: Before working inside your Embedded Box PC, read the safety information that shipped with your Embedded Box PC and follow the steps in [Before working inside your Embedded Box PC](#). After working inside your Embedded Box PC, follow the steps in [After working inside your Embedded Box PC](#). For more safety best practices, see the Regulatory Compliance home page at www.dell.com/regulatory_compliance.

Prerequisites

- 1 Follow step 1 to step 6 in "[Removing the back cover](#)".
- 2 Remove the [PCI/PCIe card](#) (if installed).
- 3 Remove the [heat sink](#).

Procedure

- 1 Remove the nut and washer that secure the barrel connector to the chassis.
- 2 Push the barrel connector through the slot chassis.
- 3 Remove the screw that secures the grounding cable to the system board.
- 4 Disconnect the power cable from the system board.



5 Remove the power cable from the routing guide on the system board

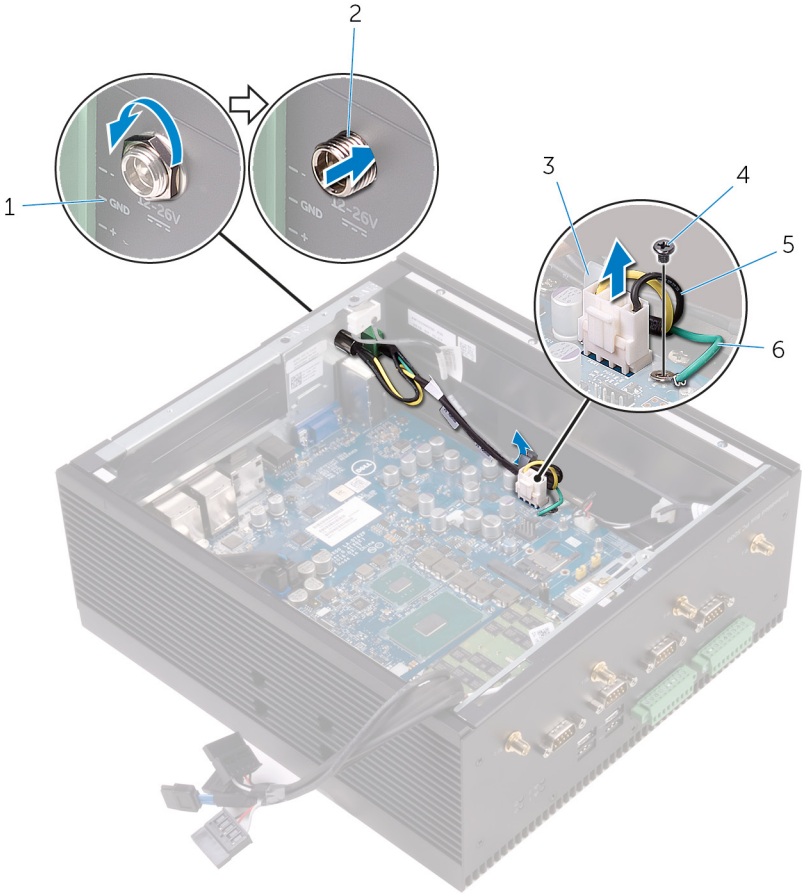

1 chassis

2 barrel connector

3 routing guide

4 M2.5x2 screw

5 power cable

6 grounding cable

6 Remove the screws that secure the power connector to the chassis.

- 7 Route the power cables along with the barrel connector through the slot on the chassis and remove it from the chassis.



1 chassis

2 power connector

3 M2.5x6 screws (2)



Replacing the power connectors



WARNING: Before working inside your Embedded Box PC, read the safety information that shipped with your Embedded Box PC and follow the steps in [Before working inside your Embedded Box PC](#). After working inside your Embedded Box PC, follow the steps in [After working inside your Embedded Box PC](#). For more safety best practices, see the Regulatory Compliance home page at www.dell.com/regulatory_compliance.

Procedure

- 1 Insert the power cables along with the barrel connector through the slot on the chassis.
- 2 Replace the screws that secure the power connector to the chassis.
- 3 Route the power cable through the routing guide on the system board.
- 4 Connect the power cable to the system board.
- 5 Replace the screw that secures the grounding cable to the system board.
- 6 Insert the barrel connector through the chassis.
- 7 Replace the nut and washer that secure the barrel connector to the chassis.

Post-requisites

- 1 Replace the [heat sink](#).
- 2 Replace the [PCI/PCIe card](#) (if necessary).
- 3 Follow step 2 to step 8 in "[Replacing the back cover](#)".

Removing the top cover



WARNING: Before working inside your Embedded Box PC, read the safety information that shipped with your Embedded Box PC and follow the steps in [Before working inside your Embedded Box PC](#). After working inside your Embedded Box PC, follow the steps in [After working inside your Embedded Box PC](#). For more safety best practices, see the Regulatory Compliance home page at www.dell.com/regulatory_compliance.

Prerequisites

- 1 Follow step 1 to step 6 in "[Removing the back cover](#)".
- 2 Remove the [PCI/PCle card](#) (if installed).
- 3 Remove the [CANbus cable](#).
- 4 Remove the [riser card](#).
- 5 Remove the [power connectors](#).

Procedure

- 1 Disconnect the power-switch cable and remove it from the routing guides on the chassis.



2 Remove the hexagonal screws that secure the VGA port to the top cover.

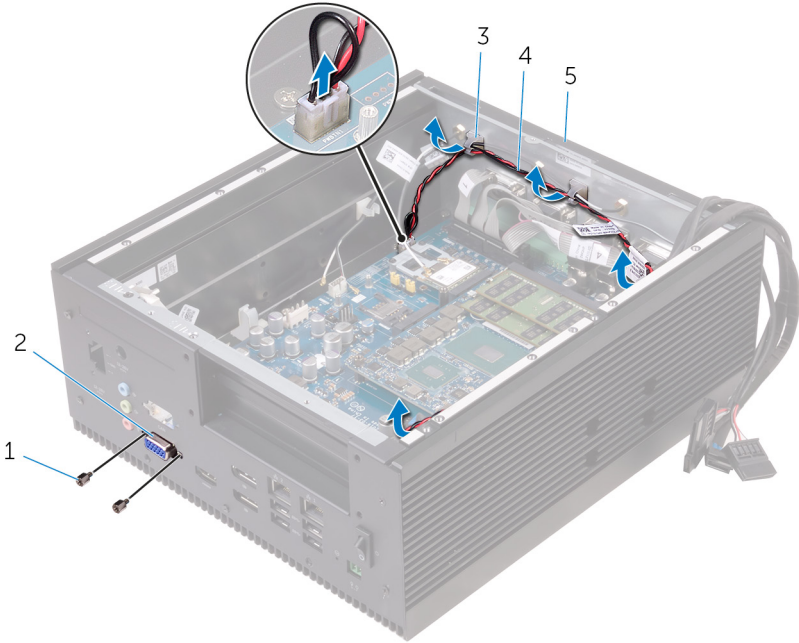

1 #4 40UNCx6.3 hexagonal screws (2)

2 VGA port

3 routing guides (4)

4 power-connector cable

5 chassis

3 Remove the screws that secure the top cover to the chassis.

- 4 Remove the top cover off the chassis.

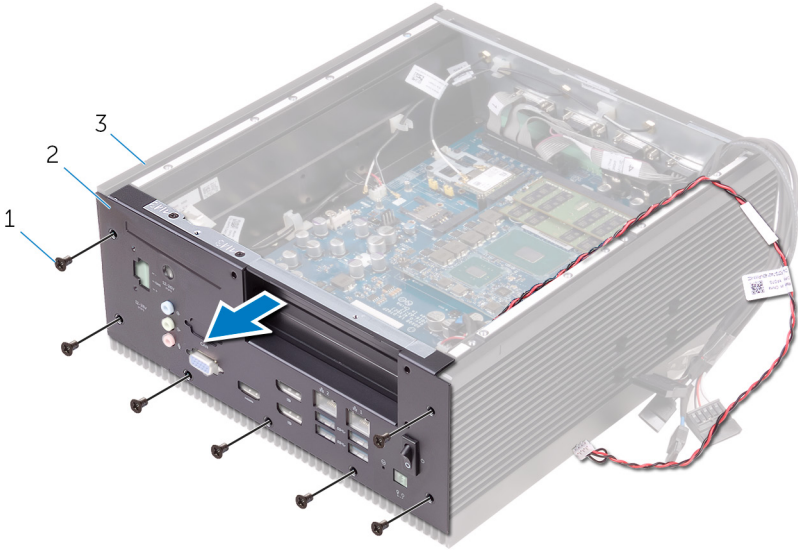

- 1 M3x5 countersunk screws (7) 2 top cover
3 chassis

- 5 Remove the [power switch](#).



Replacing the top cover



WARNING: Before working inside your Embedded Box PC, read the safety information that shipped with your Embedded Box PC and follow the steps in [Before working inside your Embedded Box PC](#). After working inside your Embedded Box PC, follow the steps in [After working inside your Embedded Box PC](#). For more safety best practices, see the Regulatory Compliance home page at www.dell.com/regulatory_compliance.

Procedure

- 1 Replace the [power switch](#).
- 2 Place the top cover on the chassis and align the screw holes on the top cover with the screw holes on the chassis.
- 3 Replace the screws that secure the top cover to the chassis.
- 4 Replace the hexagonal screws that secure the VGA port to the top cover.
- 5 Route the power-switch cable through the routing guides on the chassis.
- 6 Connect the power-switch cable to the connector on the system board.

Post-requisites

- 1 Replace the [power connectors](#).
- 2 Replace the [riser card](#).
- 3 Replace the [CANbus cable](#).
- 4 Replace the [PCI/PCIe card](#) (if necessary).
- 5 Follow step 2 to step 8 in [“Replacing the back cover”](#).

Removing the power switch



WARNING: Before working inside your Embedded Box PC, read the safety information that shipped with your Embedded Box PC and follow the steps in [Before working inside your Embedded Box PC](#). After working inside your Embedded Box PC, follow the steps in [After working inside your Embedded Box PC](#). For more safety best practices, see the Regulatory Compliance home page at www.dell.com/regulatory_compliance.

Prerequisites

- 1 Follow step 1 to step 6 in "[Removing the back cover](#)".
- 2 Remove the [PCI/PCIe card](#) (if installed).
- 3 Remove the [CANbus cable](#).
- 4 Remove the [riser card](#).
- 5 Remove the [power connectors](#).
- 6 Remove the [top cover](#).

Procedure

- 1 To release the power switch from the top cover, press the tabs on the power switch.



- 2 Route the power switch and power-switch cable through the slot on the top cover.

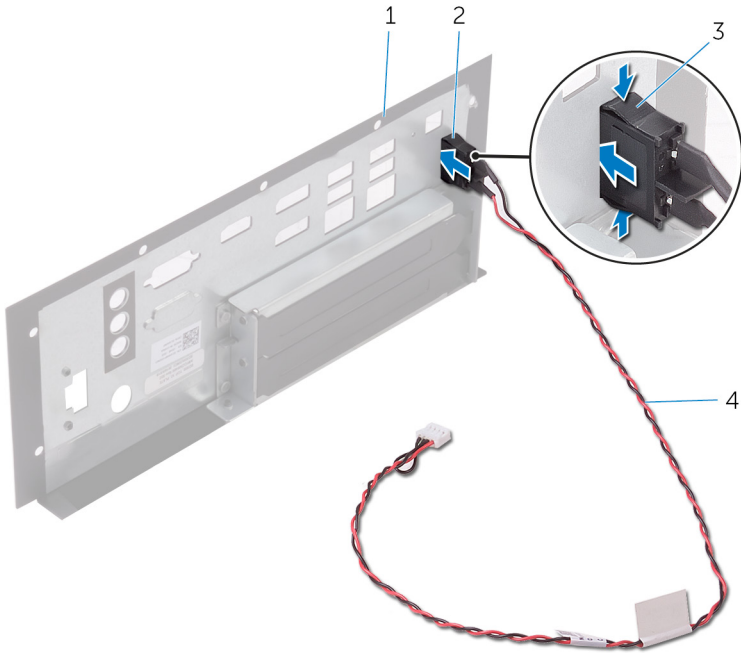

- 1 top cover
3 tabs (2)

- 2 power switch
4 power-switch cable

Replacing the power switch



WARNING: Before working inside your Embedded Box PC, read the safety information that shipped with your Embedded Box PC and follow the steps in [Before working inside your Embedded Box PC](#). After working inside your Embedded Box PC, follow the steps in [After working inside your Embedded Box PC](#). For more safety best practices, see the Regulatory Compliance home page at www.dell.com/regulatory_compliance.

Procedure

- 1 Route the power switch and power-switch cable through the slot on the top cover.
- 2 Push the power switch in to the slot and snap the power switch in place.

Post-requisites

- 1 Replace the [top cover](#).
- 2 Replace the [power connectors](#).
- 3 Replace the [riser card](#).
- 4 Replace the [CANbus cable](#).
- 5 Replace the [PCI/PCIe card](#) (if necessary).
- 6 Follow step 2 to step 8 in "[Replacing the back cover](#)".



Removing the CPU board



WARNING: Before working inside your Embedded Box PC, read the safety information that shipped with your Embedded Box PC and follow the steps in [Before working inside your Embedded Box PC](#). After working inside your Embedded Box PC, follow the steps in [After working inside your Embedded Box PC](#). For more safety best practices, see the Regulatory Compliance home page at www.dell.com/regulatory_compliance.

Prerequisites

- 1 Follow step 1 to step 6 in "[Removing the back cover](#)".
- 2 Remove the [PCI/PCIe card](#) (if installed).
- 3 Remove the [memory module](#).
- 4 Remove the [heat sink](#).

Procedure

- 1 Remove the screws that secure the CPU board to the system board.

2 Lift the CPU board off the system board.

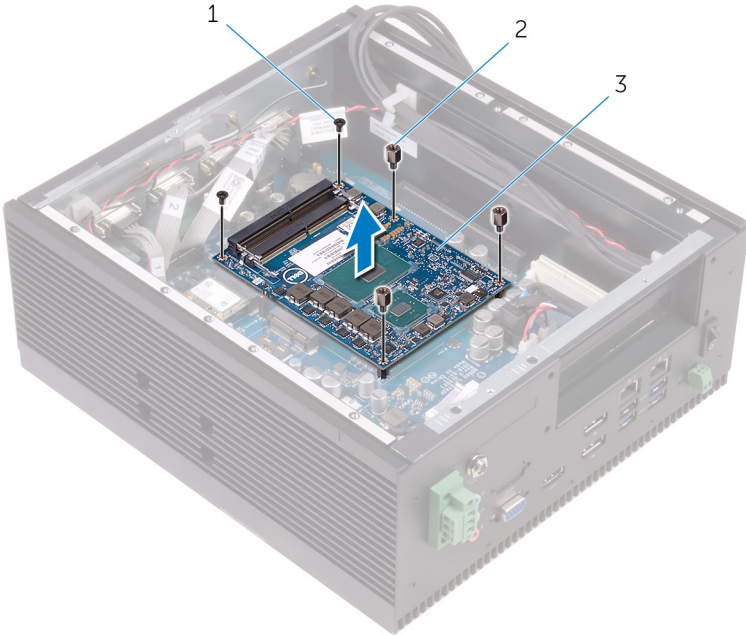

1 M2.5x6 screws (2)

2 STDF(L5) HEX, M2.5x4 screws (3)

3 CPU board



Replacing the CPU board



WARNING: Before working inside your Embedded Box PC, read the safety information that shipped with your Embedded Box PC and follow the steps in [Before working inside your Embedded Box PC](#). After working inside your Embedded Box PC, follow the steps in [After working inside your Embedded Box PC](#). For more safety best practices, see the Regulatory Compliance home page at www.dell.com/regulatory_compliance.

Procedure

- 1 Place the CPU board on the CPU-board connector the system board.
- 2 Carefully, press down on the CPU board.
- 3 Align the screw holes on the CPU board with the screw holes on the system board.
- 4 Replace the screws that secure the CPU board to the system board.

Post-requisites

- 1 Replace the [heat sink](#).
- 2 Replace the [memory module](#).
- 3 Replace the [PCI/PCIe card](#) (if necessary).
- 4 Follow step 2 to step 8 in "[Replacing the back cover](#)".

Removing the system board



WARNING: Before working inside your Embedded Box PC, read the safety information that shipped with your Embedded Box PC and follow the steps in [Before working inside your Embedded Box PC](#). After working inside your Embedded Box PC, follow the steps in [After working inside your Embedded Box PC](#). For more safety best practices, see the Regulatory Compliance home page at www.dell.com/regulatory_compliance.



NOTE: Your Embedded Box PC's Service Tag is stored in the system board. You must enter the Service Tag in the BIOS setup program after you replace the system board.



NOTE: Replacing the system board removes any changes you have made to the BIOS using the BIOS setup program. You must make the appropriate changes again after you replace the system board.



NOTE: Before disconnecting the cables from the system board, note the location of the connectors so that you can reconnect the cables correctly after you replace the system board.

Prerequisites

- 1 Follow step 1 to step 6 in "[Removing the back cover](#)".
- 2 Remove the [PCI/PCIe card](#) (if installed).
- 3 Remove the [WLAN-antenna connectors](#).
- 4 Remove the [WLAN card](#).
- 5 Remove the [WWAN-antenna connectors](#).
- 6 Remove the [CANbus card](#) or [WWAN card](#).
- 7 Remove the [SIM card](#).
- 8 Remove the [intrusion switch](#).
- 9 Remove the [memory module](#).
- 10 Remove the [heat sink](#).
- 11 Remove the [riser card](#).
- 12 Remove the [power connectors](#).
- 13 Follow step 1 to step 4 in [Removing the top cover](#).



- 14 Remove the [CPU board](#).

Procedure

- 1 Disconnect the serial-port cable, SATA data-cable, and SATA power-cable from the system board.

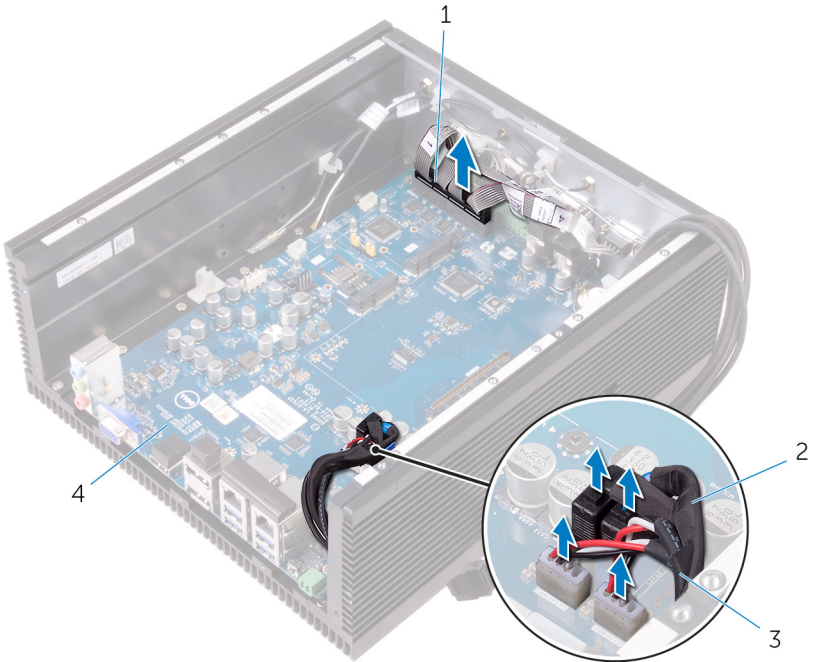

- | | | | |
|---|----------------------|---|---------------------|
| 1 | serial-port cable | 2 | SATA data-cable (2) |
| 3 | SATA power-cable (2) | 4 | system board |

- 2 Remove the screws that secure the system board to the chassis.

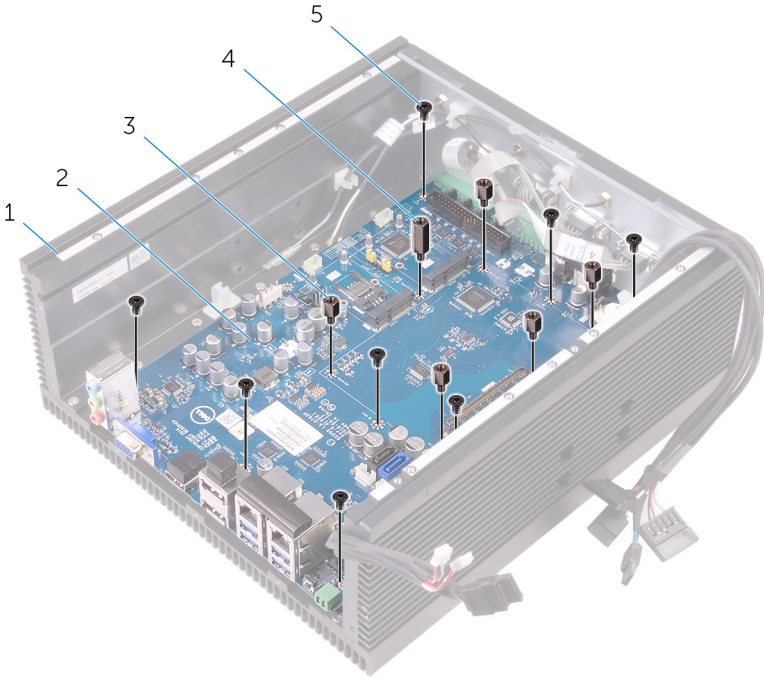

- | | | | |
|---|-------------------------------|---|--------------------------------|
| 1 | chassis | 2 | system board |
| 3 | STDF(L8) HEX, M3x4 screws (5) | 4 | STDF(L15) HEX, M3x4 screws (1) |
| 5 | M3x5 screws (8) | | |



3 Lift the system board off the chassis.

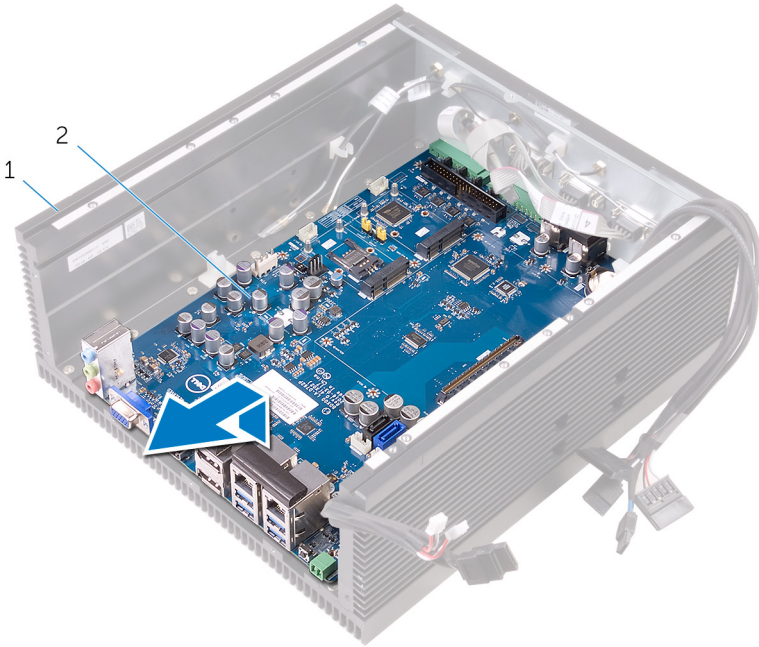

1 chassis

2 system board

Replacing the system board

 **WARNING:** Before working inside your Embedded Box PC, read the safety information that shipped with your Embedded Box PC and follow the steps in [Before working inside your Embedded Box PC](#). After working inside your Embedded Box PC, follow the steps in [After working inside your Embedded Box PC](#). For more safety best practices, see the Regulatory Compliance home page at www.dell.com/regulatory_compliance.

 **NOTE:** Your Embedded Box PC's Service Tag is stored in the system board. You must enter the Service Tag in the BIOS setup program after you replace the system board.

 **NOTE:** Replacing the system board removes any changes you have made to the BIOS using the BIOS setup program. You must make the appropriate changes again after you replace the system board.

Procedure

- 1 Place the system board on the chassis.
- 2 Align the screw holes on the system board with the screw holes in the chassis.
- 3 Replace the screws that secure the system board to the chassis.
- 4 Connect the serial-port cable, SATA data-cable, and SATA power-cable to the connectors on the system board.

Post-requisites

- 1 Replace the [CPU board](#).
- 2 Follow step 2 to step 6 in [Replacing the top cover](#).
- 3 Replace the [power connectors](#).
- 4 Replace the [riser card](#).
- 5 Replace the [heat sink](#).
- 6 Replace the [memory module](#).
- 7 Replace the [intrusion switch](#).
- 8 Replace the [SIM card](#).
- 9 Replace the [CANbus card](#) or [WWAN card](#).



- 10 Replace the [WWAN-antenna connectors](#).
- 11 Replace the [WLAN card](#).
- 12 Replace the [WLAN-antenna connectors](#).
- 13 Replace the [PCI/PCIe card](#) (if necessary).
- 14 Follow step 2 to step 8 in "[Replacing the back cover](#)".

Entering the Service Tag in the BIOS setup program

- 1 Turn on or restart the Embedded Box PC.
- 2 Press F2 when the Dell logo is displayed to enter the BIOS setup program.
- 3 Navigate to the **Main** tab and enter the Service Tag in the **Service Tag Input** field.



BIOS setup program

Entering BIOS setup program

Before turning on the Embedded Box PC, connect the keyboard, mouse, and monitor to the Embedded Box PC, or connect the Embedded Box PC through the KVM session or use Dell Wyse Cloud Client Manager (CCM) or Dell Command | Monitor (DCM) to update the BIOS configuration.

- 1 Turn on (or restart) the Embedded Box PC.
- 2 During POST, when the DELL logo is displayed, watch for the F2 prompt to appear, and then press F2 immediately.



NOTE: The F2 prompt indicates that the keyboard is initialized. This prompt can appear very quickly, so you must watch for it, and then press F2. If you press F2 before the F2 prompt, this keystroke is lost. If you wait too long and the operating system logo appears, continue to wait until you see the desktop. Then, restart the Embedded Box PC and try again.

Clearing forgotten passwords



NOTE: The Embedded Box PC must be disconnected from the electrical outlet to clear the password setting.

- 1 Follow step 1 to step 6 in [“Removing the back cover”](#).
- 2 Locate the password reset jumper (PWD) on the system board. See [“System-board components”](#).
- 3 Move the jumper plug from pins 1 and 2 to 2 and 3.
- 4 Follow step 2 to step 9 in [“Replacing the back cover”](#).
- 5 Turn on the Embedded Box PC, and wait until the message stating that the password has been cleared appears.
- 6 Shut down the Embedded Box PC.



- 7 Move the jumper plug from pins 2 and 3 and replace it on pins 1 and 2.

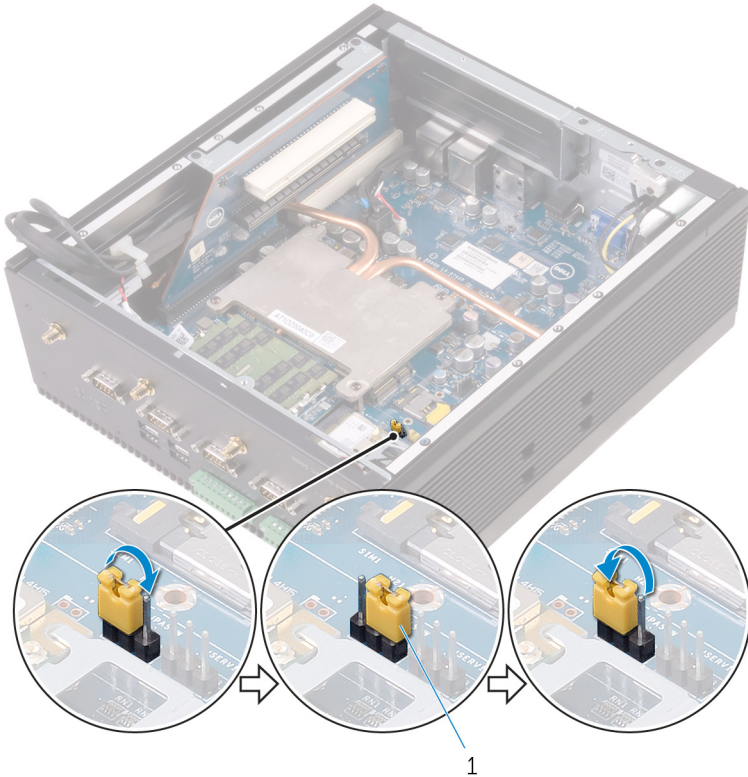

1 jumper plug

- 8 Follow step 2 to step 9 in [“Replacing the back cover”](#).

Clearing CMOS settings

- 1 Follow step 1 to step 6 in [“Removing the back cover”](#).
- 2 Locate the CMOS reset jumper (CMOS) on the system board. See [“System-board components”](#).
- 3 Move the jumper plug from pins 1 and 2 to 2 and 3.
- 4 Follow step 2 to step 9 in [“Replacing the back cover”](#).

- 5 Turn on the Embedded Box PC, and wait until the message stating that the CMOS has been cleared appears.
- 6 Shut down the Embedded Box PC.
- 7 Move the jumper plug from pins 2 and 3 to pins 1 and 2.

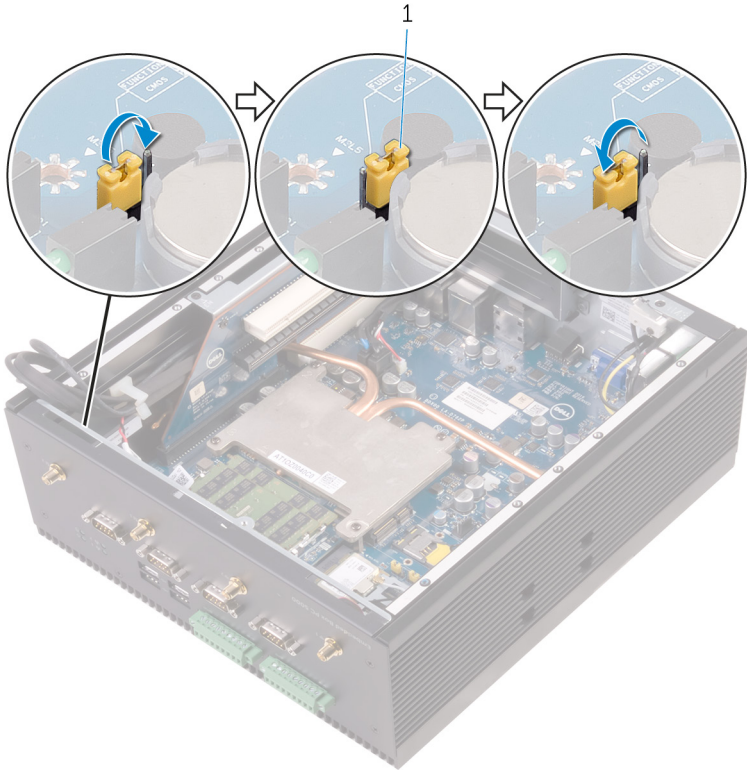

1 jumper plug

- 8 Follow step 2 to step 8 in [“Replacing the back cover”](#).



Removing the Dell logo board



WARNING: Before working inside your Embedded Box PC, read the safety information that shipped with your Embedded Box PC and follow the steps in [Before working inside your Embedded Box PC](#). After working inside your Embedded Box PC, follow the steps in [After working inside your Embedded Box PC](#). For more safety best practices, see the Regulatory Compliance home page at www.dell.com/regulatory_compliance.

Prerequisites

- 1 Follow step 1 to step 6 in "[Removing the back cover](#)".
- 2 Remove the [PCI/PCIe card](#) (if installed).
- 3 Remove the [WLAN-antenna connectors](#).
- 4 Remove the [WLAN card](#).
- 5 Remove the [WWAN-antenna connectors](#).
- 6 Remove the [CANbus card](#) or [WWAN card](#).
- 7 Remove the [SIM card](#).
- 8 Remove the [intrusion switch](#).
- 9 Remove the [bottom cover](#).
- 10 Remove the [memory module](#).
- 11 Remove the [heat sink](#).
- 12 Remove the [riser card](#).
- 13 Remove the [power connectors](#).
- 14 Follow step 1 to step 4 in [Removing the top cover](#).
- 15 Remove the [CPU board](#).

Procedure

1 Remove the screws that secure the left chassis to the front chassis.

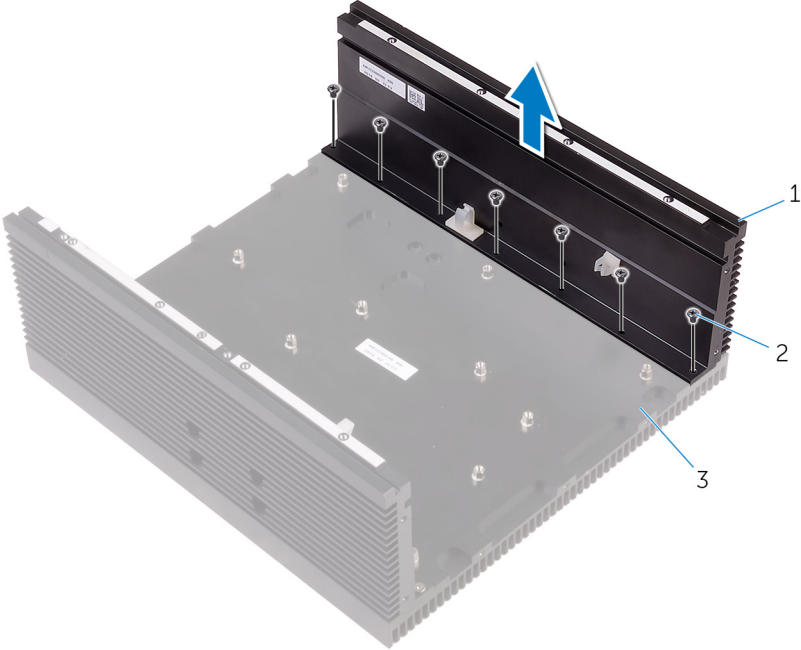

- 1 left chassis
- 3 front chassis

- 2 M3x6 screws (7)



2 Remove the screws that secure the Dell logo board to the front chassis.

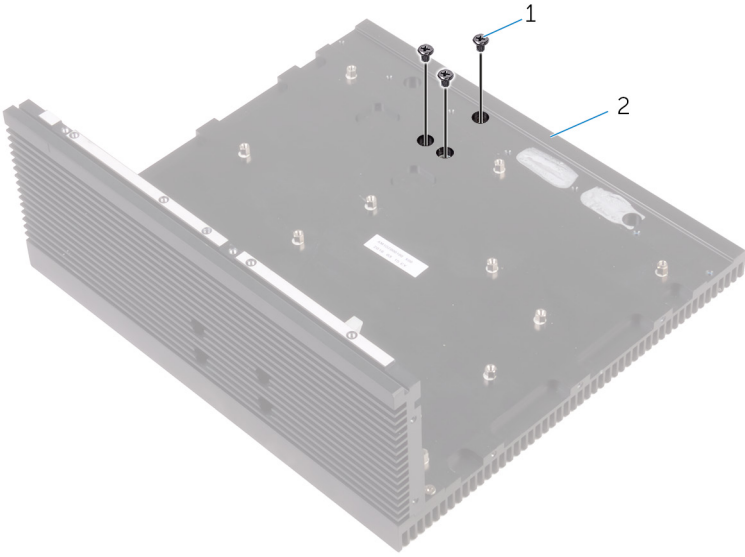

1 M3x5 screws (3)

2 front chassis

3 Remove the Dell logo board from the front chassis.

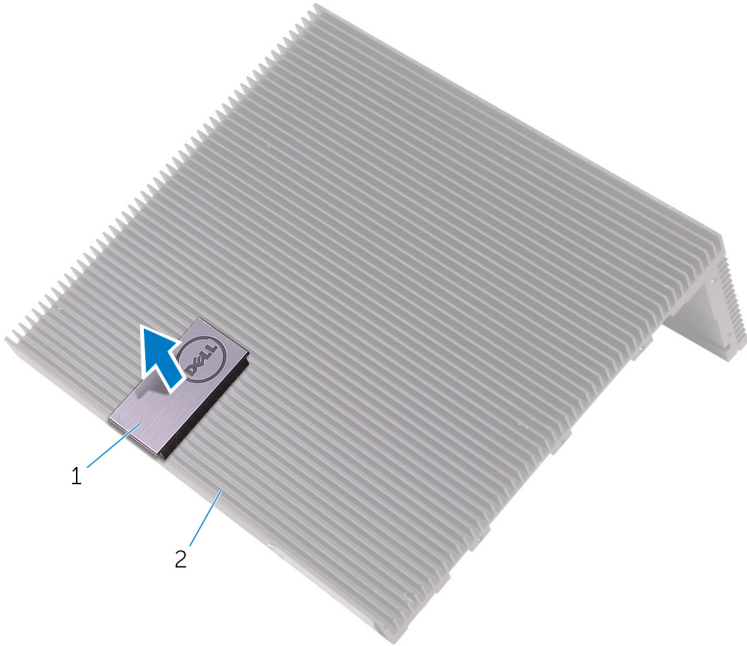

1 Dell logo board

2 front chassis



Replacing the Dell logo board



WARNING: Before working inside your Embedded Box PC, read the safety information that shipped with your Embedded Box PC and follow the steps in [Before working inside your Embedded Box PC](#). After working inside your Embedded Box PC, follow the steps in [After working inside your Embedded Box PC](#). For more safety best practices, see the Regulatory Compliance home page at www.dell.com/regulatory_compliance.

Procedure

- 1 Place the Dell logo board into the front chassis.
- 2 Replace the screws that secure the Dell logo board to the chassis.
- 3 Align the screw holes on the left chassis with the screw holes on the front chassis.
- 4 Replace the screws that secure the left chassis to the front chassis.

Post-requisites

- 1 Replace the [CPU board](#).
- 2 Follow step 2 to step 6 in [Replacing the top cover](#).
- 3 Replace the [power connectors](#).
- 4 Replace the [riser card](#).
- 5 Replace the [heat sink](#).
- 6 Replace the [memory module](#).
- 7 Replace the [bottom cover](#).
- 8 Replace the [intrusion switch](#).
- 9 Replace the [SIM card](#).
- 10 Replace the [CANbus card](#) or [WWAN card](#).
- 11 Replace the [WWAN-antenna connectors](#).
- 12 Replace the [WLAN card](#).
- 13 Replace the [WLAN-antenna connectors](#).
- 14 Replace the [PCI/PCIe card](#) (if necessary).



15 Follow step 2 to step 8 in [“Replacing the back cover”](#).



Technology and components

Power

The Dell Embedded Box PC is shipped with the 12-26V DC power adapter.

Processor

The Dell Embedded Box PC is shipped with Intel Celeron G3900E, Intel Core i3-6100E, Intel Core i5-6440EQ, and Intel Core i7-6820EQ processor.

Mechanical

The Embedded Box PC is optimized for fanless design, and easy wall/panel and DIN Rail Mount use. It provides easy access to connectors and switches. The Embedded Box PC also supports Dell branded and Unbranded OEM ready front cover versions.

Feature	Description
Primary unit	<ul style="list-style-type: none">• Optimized for Fanless design• Optimized for easy wall/panel and DIN Rail Mount use• Easy access to connectors and switches• Dell branded and Unbranded OEM ready front cover versions
Operating temperature	<ul style="list-style-type: none">• Operating (Hard drive): 0°C to 40°C (32°F to 104°F)• Operating (Solid-state drive): 0°C to 50°C (32°F to 122°F)• Non-operating: -40°C to 65°C (-40°F to 149°F)
Humidity	<ul style="list-style-type: none">• Operating: 10% to 90% (non-condensing)

Feature	Description
Environmental	<ul style="list-style-type: none"> Non-operating: 5% to 95% (non-condensing)
Mounting	<p data-bbox="580 293 908 317">Base device: Dust-resistant IP30</p> <ul style="list-style-type: none"> Wall-mount bracket Mechanism for securing system on DIN rail

Peripherals

The following peripherals are available in the Embedded Box PC:

- Wall-mount bracket
- Power connector kit
- Multi-Function port
- Mobile Broadband card
- Mobile WLAN card
- CANbus card
- Power adapter

WLAN/WWAN

The following WLAN and WWAN cards are optionally offered in the Embedded Box PC:

- Dual-band 802.11b/g/n/ac+Bluetooth 4.1 LE
- Dell Wireless DW5580 HSPA+

Zigbee

The Zigbee USB module is a wireless mesh module for Dell Embedded Box PC.



CANbus

The CANBus daughter card is an optional accessory for Embedded Box PC.

